

# MAYA FIRE & WIDE SPILL WATER BOWL

GFRC CONCRETE

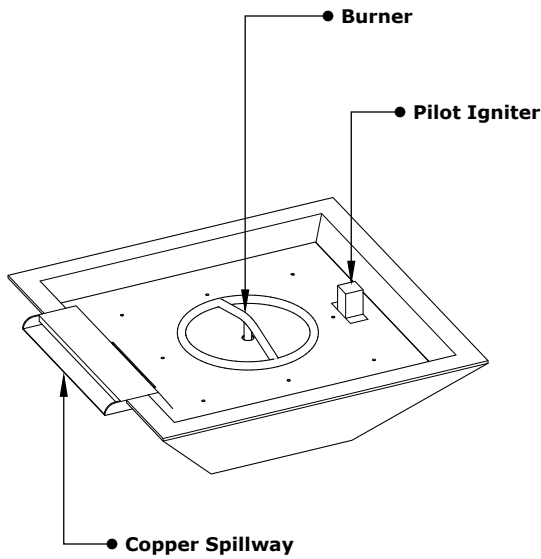

**ISOMETRIC VIEW**

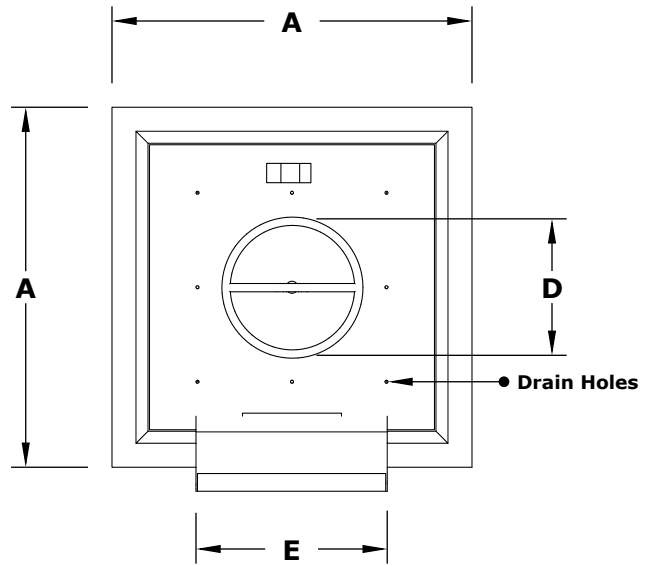

**TOP VIEW**

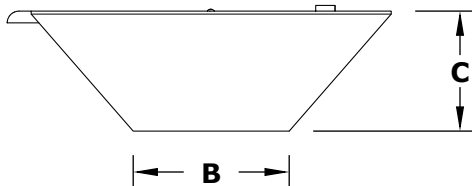

**RIGHT SIDE VIEW**

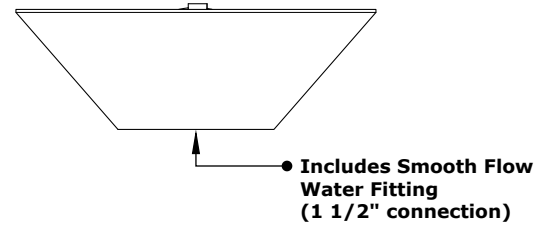

**BACK SIDE VIEW**

PART NUMBER	A	B	C	D	E	GPM	BTU
OPT-24SFWWS	24"	13"	10.75"	8"	12"	15	45,000
OPT-24SFWWSE12V	24"	13"	10.75"	8"	12"	15"	45,000
OPT-30SFWWS	30"	13"	10.25"	8"	16"	15"	45,000
OPT-30SFWWSE12V	30"	13"	10.25"	8"	16"	15"	45,000
OPT-36SFWWS	36"	20"	12"	12"	20"	15"	65,000
OPT-36SFWWSE12V	36"	20"	12"	12"	20"	15"	65,000

Fire Pit Material: GFRC Concrete  
 Pan Material: 304 Stainless Steel  
 Burner Material: 304 Stainless Steel  
 Standard 2" Depth on all pans  
**12V ELECTRONIC IGNITION**  
 ANSI Z21.97-(2017) / CSA 2.41-(2017)



Match Lit Unit Includes: Pan, Burner, Gas Orifice, Gas Hoses, Key Valve, Key,  
 110v Ignition Unit Includes: Pan, Burner, Gas Orifice, Gas Hoses, Key Valve, Key, Plug & Play Electronic Valve, Pilot Igniter.