



# 1410T/LCD-A

## INSTALLATION AND OPERATING INSTRUCTIONS

**IF YOU CANNOT READ OR UNDERSTAND THESE INSTALLATION INSTRUCTIONS, DO NOT ATTEMPT TO INSTALL OR OPERATE**

### INTRODUCTION

This SKYTECH remote control system was developed to provide safe, reliable, and user-friendly remote control system for gas heating appliances. The remote system is powered by 110-120 VAC, yet only a “dry contact” (no power output). The system operates on radio frequencies with non-directional signals. The system can be operated manually from the transmitter. The system operates on one of 1,048,576 security codes that are programmed into the transmitter at the factory.

Review **COMMUNICATION SAFETY SECTION** under TRANSMITTER section. This safety features shut down the fireplace system when a potentially unsafe condition exists.

### TRANSMITTER

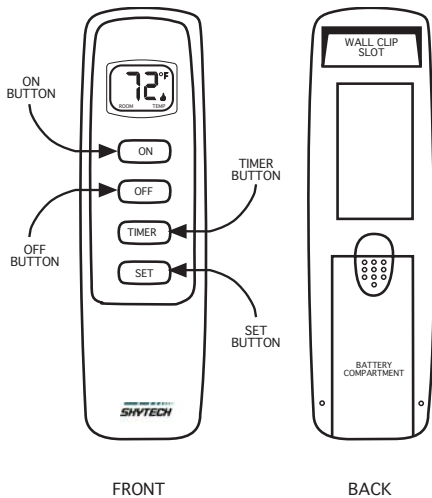

This remote control SYSTEM offers the user a battery-operated remote control that operates most millivolt gas valves used in some heater rated gas logs, gas fireplaces and other gas heating appliances.

The transmitter operates on (2) 1.5V AAA batteries.

It is recommended that ALKALINE batteries always be used for longer battery life and maximum operational performance.

Before using the transmitter, install the (2) AAA transmitter batteries into the battery compartment. (Use caution that batteries are installed in the proper direction)

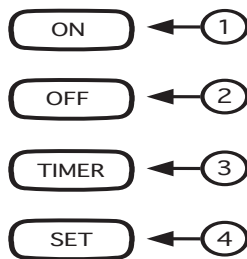

### KEY SETTINGS

- ON - Operates unit to on position, Manually ON.
- OFF - Operates unit to off position, Manually OFF.
- TIMER - Changes unit from manual mode to timer mode.
- SET - Sets the timer in minutes.

### LCD - Liquid Crystal Display

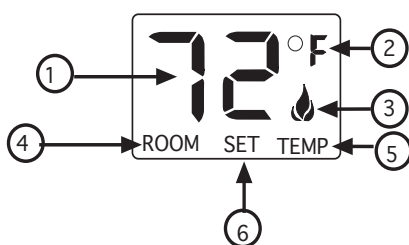

1. **DISPLAY** - Indicates CURRENT room temperature .
2. **° F OR ° C** - Indicates degrees Fahrenheit or Celsius.
3. **FLAME** - Indicates burner/valve in operation.
4. **ROOM** - Appears when LCD screen is on
5. **TEMP** - Appears when LCD screen is on.
6. **SET** - Appears when setting the timer.

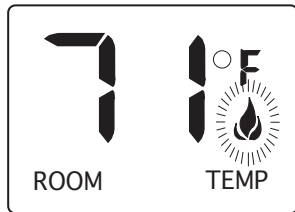
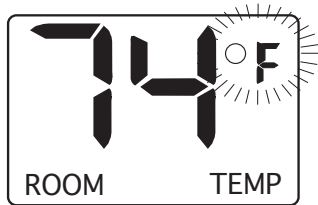

### ON MODE

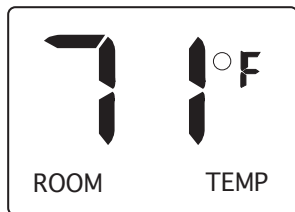

### OFF MODE

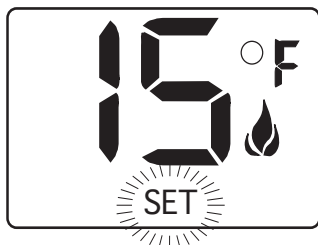

### SET MODE



### COUNT DOWN MODE

### SETTING ° F / ° C SCALE

The factory setting for temperature is ° F. To change this setting to ° C, first

- Press the ON key and the OFF key on the transmitter at the same time. This will change from ° F to ° C. Follow this same procedure to change from ° C back to ° F.

### MANUAL FUNCTION

To operate the system in the manual "MODE" follow these steps.

#### ON OPERATION

Press the ON key; the appliance flame will come on. During this time the LCD screen will display the room temperature and the Flame icon.

#### OFF OPERATION

Press the OFF key; the appliance flame will shut off. During this time the LCD screen will display the room temperature. **(The Flame icon will not appear)**

### TIMER FUNCTION

#### SETTING DESIRED TIME

To operate the (3) hour count down feature following steps.

Press the ON button to start the appliance. Note the transmitter must be ON for the TIMER feature to operate

Press the TIMER button. The LCD screen will show the word SET.

Press and release the SET button until the desired time is reached minute intervals. (15-30-45-60-75-90-105-120-135-150-165-180) Note: the LCD display will flash the set time for (2) seconds then default to the set time and count down in minutes until set time has elapsed

Press the OFF button to disengage the timer.

## RECEIVER

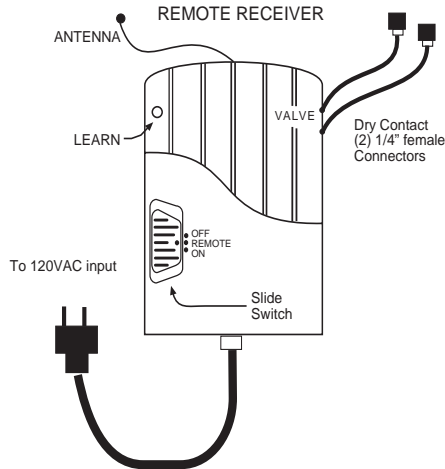

When plugged into a standard 110-120 VAC receptacle, the remote receiver operates on commands from the transmitter or from the slide switch on the face of the receiver (This switch is to be used during a power outage to operate the appliance manually). The remote receiver is manufactured with a “dry contact” relay in its circuitry that operates like an on/off switch, however, no power or current passes from the 110-120 VAC input side to the wires leading from the output side of the remote receiver.

This 1410T/LCD-A remote control system can be used in simplified installations to control a millivolt gas valve without any additional relays or components.

## LOCATING THE RECEIVER

PROTECTION FROM EXTREME HEAT IS VERY IMPORTANT. Like any piece of electronic equipment, the remote receiver should be kept away from temperatures exceeding 130<sup>0</sup> F. Exposure to extreme temperatures can damage the electronic components or cause the plastic case to become deformed and is not covered under warranty.

### WARNING

THIS REMOTE CONTROL SYSTEM MUST BE INSTALLED EXACTLY AS OUTLINED IN THESE INSTRUCTIONS. READ ALL INSTRUCTIONS COMPLETELY BEFORE ATTEMPTING INSTALLATION. FOLLOW INSTRUCTIONS CAREFULLY DURING INSTALLATION. ANY MODIFICATION OF THIS REMOTE CONTROL OR ANY OF ITS COMPONENTS WILL VOID THE WARRANTY AND MAY POSE A FIRE HAZARD.

## WIRING INSTRUCTIONS

A qualified electrician or a gas technician who is familiar with the gas appliance and gas valves that will be operated by this remote should install the remote control system. Incorrect wiring connections **WILL** cause damage to the gas valve or electronic module operating the gas appliance and may also damage the remote receiver.

## WIRING MILLIVOLT VALVES

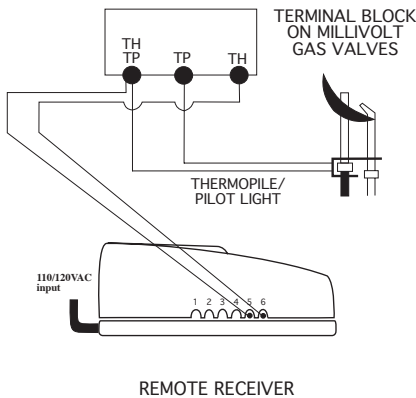

The remote receiver is to be connected to the millivolt valve.

Connect one of the (2) 18 gauge wires from the 1410T/LCD-A receiver to the TH terminal and the other to the THTP terminal on the terminal block on the millivolt gas valve.

Operation of the remote receiver is similar to that of a thermostat in that both turn the gas valve on and off based on input signals. A thermostat's input signals are different temperatures. The remote receiver's input signals come from the transmitter.

## WIRING ELECTRONIC SPARK IGNITIONS

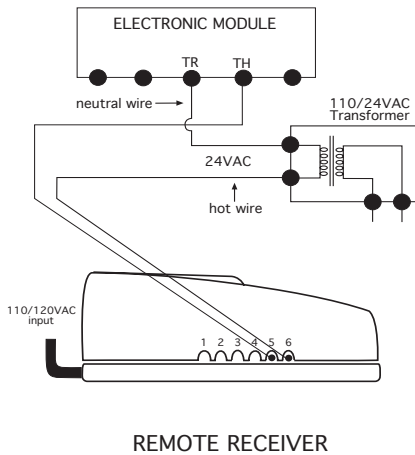

Most electronic systems operate on a 110 VAC/24VAC power transformer used to power the system electronic ignition module and electronic gas valve, which can be controlled by the 1410-A remote receiver as, illustrated.

**NOTE:** THE 110-120 VAC/ 24VAC, transformer may be purchased from your appliance dealer, or an electronic parts distributor.

The remote control receiver can be connected, in series, to a 24VAC transformer to the TR (transformer) terminal on the ELECTRONIC MODULE. Connect the hot wire from the 24VAC transformer to either of the wires on the remote receiver. Connect the other wire from the receiver to the TH (thermostat) terminal on the ELECTRONIC MODULE.

## SYSTEM CHECK

### MILLIVOLT VALVES

Light your gas appliance following the lighting instructions that came with the appliance. Confirm that the pilot flame is on; it must be in operation for the main gas valve to operate.

- Slide the 3-position button on the remote receiver to the ON position. The main gas flame (i.e., the fire) should ignite.
- Slide the button to OFF. The flame should extinguish (the pilot flame will remain on).
- Slide the button to REMOTE (the center position) then press the ON button on the transmitter to change the system to ON. The main gas flame should ignite.

### ELECTRONIC IGNITION SYSTEMS

- Slide the 3-position button on the remote receiver to the ON position. The spark electrode should begin sparking to ignite the pilot (the pilot may ignite after only one spark). After the pilot flame is lit, the main gas valve should open and the main gas flame should ignite.
- Slide the button to OFF. The main gas flame and pilot flame should BOTH extinguish.
- Slide the button to REMOTE (the center position), and then press the ON button on the transmitter to change the system to ON. The spark electrode should begin sparking to ignite the pilot. After the pilot is lit, the main gas valve should open and the main gas flame should ignite.

## GENERAL INFORMATION

### CP (CHILDPROOF) FEATURE

This SKYTECH remote control includes a CHILDPROOF “LOCK-OUT” feature that allows the user to “LOCK-OUT” operation of the appliance, from the TRANSMITTER.

### SETTING “LOCK-OUT” – (CP)

- To activate the “LOCK-OUT” feature, press and hold the ON button and the TIMER button at the same time for 5 seconds. The letters CP will appear in the TEMP frame on the LCD screen.
- To disengage the “LOCK-OUT”, press and hold the ON button and the TIMER button at the same time for 5 seconds and the letters CP will disappear from the LCD screen and the transmitter will return to its normal operating condition.
- To verify that transmitter is in the CP lock-out mode press any key and the LCD screen will show “CP”

**NOTE:** If the appliance is already operating in the ON or TIMER mode, engaging the “LOCK-OUT” will not cancel the operating MODE. Engaging the “LOCK-OUT” prevents only the manual operation of the TRANSMITTER. If in the auto modes, the TIMER operation will continue to operate normally. To totally “LOCK-OUT” the operation of the TRANSMITTER’S operating signals; the transmitters OFF must be set to OFF.

### **TEMPERATURE UPDATING FEATURE –TRANSMITTER – (T/S –TX)**

This SKYTECH remote control has a TEMPERATURE UPDATING Feature built into its software. The TEMPERATURE UPDATING Feature operates in the following manner.

The transmitter reads the ROOM temperature every 2 minutes then updates the ROOM temperature on the LCD screen.

### **COMMUNICATION – SAFETY – TRANSMITTER – (C/S – TX)**

This SKYTECH remote control has a COMMUNICATION –SAFETY function built into its software. It provides an extra margin of safety when the TRANSMITTER is out of the normal 20-foot operating range of the receiver.

The COMMUNICATION – SAFETY feature operates in the following manner, in all OPERATING MODES – ON/ ON TIMER.

At all times and in all OPERATING MODES, the transmitter sends an RF signal every fifteen (15) minutes, to the receiver, indicating that the transmitter is within the normal operating range of 20 feet. Should the receiver NOT receive a transmitter signal every 15 minutes, the IC software, in the RECEIVER, will begin a 2-HOUR (120-minute) countdown timing function. If during this 2-hour period, the receiver does not receive a signal from the transmitter, the receiver will shut down the appliance being controlled by the receiver. The RECEIVER will then emit a series of rapid “beeps” for a period of 10 seconds. Then after 10 seconds of rapid beeping, the RECEIVER will continue to emit a single “beep” every 4 seconds until a transmitter ON or MODE Button is pressed to reset the receiver. The intermittent 4-second beeping will go on for as long as the receiver has power.

To “reset” the RECEIVER and operate the appliance, you must press the ON or TIMER button on the transmitter. By turning the system to ON, the COMMUNICATION -SAFETY operation is overridden and the system will return to normal operation depending on the MODE selected at the transmitter. The COMMUNICATION – SAFETY feature will reactivate should the transmitter be taken out of the normal operating range or should the transmitter’s batteries fail or be removed.

### **MATCHING SECURITY CODES**

Each transmitter can use one of 1,048,576 unique security codes. It may be necessary to program the remote receiver to LEARN the security code of the transmitter upon initial use, if batteries are replaced, or if a replacement transmitter is purchased from your dealer or the factory. When matching security codes, be sure slide button on the receiver is in the REMOTE position; the code will NOT “LEARN” if the slide switch is in the ON or OFF position. Program the remote receiver to LEARN a new security code **Push and Release** the LEARN button on the top of the remote receiver and then **Press** the ON or OFF button on the transmitter. A change in the beeping pattern, at the receiver, indicates the transmitter’s code has been programmed into the receiver. When an existing receiver is matched to a new transmitter, the new security code will override the old one.

The microprocessor that controls the security code matching procedure is controlled by a timing function. If you are unsuccessful in matching the security code on the first attempt, wait 1-2 minutes before trying again – this delay allows the microprocessor to reset its timer circuitry – and try up to two or three more times.

### **BATTERY LIFE**

Life expectancy of the alkaline batteries in the transmitter should be at least 12 months. Check and replace the transmitter battery annually. When the transmitter no longer operates the remote receiver from a distance it did previously (i.e., the transmitter’s range has decreased) or the remote receiver does not function at all, the transmitter battery and the 110-volt power source to the receiver should be checked. The transmitter should operate with as 2.5 volts of battery power, measuring at the (2) 1.5-volt batteries.

### **TROUBLE SHOOTING**

If you encounter problems with your fireplace system, the problem may be with the fireplace itself or it could be with the SKYTECH remote. Review the fireplace manufacturer’s operation manual to make sure all connections are properly made. Then check the operation of the SKYTECH remote in the following manner:

- Make sure there is 110-volt power source to the receiver. Without 110-volt power the receiver will not operate with the transmitter.
- Check battery in Transmitter to make sure contacts are touching (+) and (-) ends of battery. Bend metal contacts in for tighter fit.
- Be sure RECEIVER and Transmitter is within 20’-25’ operating range.
- If RECEIVER is installed in tightly enclosed metal surround, the operating distance will be shortened.

## FREQUENCY (DISTANCE) ADJUSTMENT PROCEDURE

### TRANSMITTER ADJUSTMENT – RECOMMENDED ADJUSTMENT

1. To adjust at the transmitter, use a small slotted screwdriver.
2. Remove the small sticky DOT on the back top of the transmitter.
3. Turn the adjustment screw clock-wise about 5 degrees or a maximum of less than 1/8 turn. this should correct the distance problem.
4. If that does not correct the problem, return adjustment screw to original position and then turn adjustment screw counter-clockwise.

NOTE: This adjustment is like tuning your radio. If you keep turning the adjustment screw, in either direction, you will go past the proper setting (tuning).

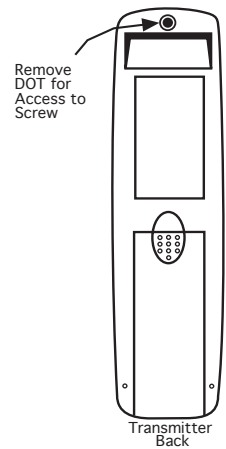

## SPECIFICATIONS

### ELECTRICAL LOAD RATINGS FOR INDOORS USE ONLY



LISTED  
13F7  
Appliance  
Control

ELECTRICAL RATINGS  
Input: 120 VAC; 60 Hz  
Output: 2.5 A; 24 VAC/60Hz or 24 VDC

BATTERIES: Transmitter (2) 1.5V Alkaline (AAA)  
Remote Receiver 110-120 VAC; 60 Hz  
Operating Frequency: 303.875 MHZ

FCC ID No.'s: transmitter –K9L SP1001TH receiver – K9L1410RX  
Canadian ISC ID No.'s: transmitter –2439A-SP1001TH receiver – 2439A-1410RX

### FCC REQUIREMENTS

**NOTE: THE MANUFACTURER IS NOT RESPONSIBLE FOR ANY RADIO OR TV INTERFERENCE CAUSED BY UNAUTHORIZED MODIFICATIONS TO THIS EQUIPMENT. SUCH MODIFICATIONS COULD VOID THE USER'S AUTHORITY TO OPERATE THE EQUIPMENT.**

FOR TECHNICAL  
SERVICE, CALL:

U.S. INQUIRIES  
888/672-8929 or  
260/459-1703

Website: skytechsystem.com

CANADIAN INQUIRIES  
877/472-3923

**MANUFACTURED EXCLUSIVELY FOR SKYTECH II, INC**

# Limited Lifetime Warranty

SKYTECH II warrants the SKYTECH REMOTE CONTROL SYSTEM for a Limited Lifetime of the original owner of this system. This warranty is not transferable to another person it is for the original purchaser of the product. Should any part fail because of defective workmanship or material from the original date of purchase. SKYTECH II will repair or, at SKYTECH II option, replace the defective parts.

Replacement parts will be available at no charge for the first (5) five years of this warranty, and will be available at market cost for the Lifetime of the product to that original owner. If SKYTECH II does not have the parts for an individual model, then a replacement SYSTEM will be provided. At no charge for the first (5) five years and sold at market cost for the Lifetime of that product to the original owner.

The Owner must provide a bill of sale, cancelled check, or payment record should be kept to verify purchase date and establish warranty period. Travel, diagnostic cost, service labor to repair the defective SYSTEM, and freight charges on warranty parts to and from the factory will be the responsibility of the owner. SKYTECH will not be responsible for labor charges and/or damage incurred in installation, repair, replacement, or for incidental or consequential damages. Batteries and any damage caused by them are not covered by them are not covered by this warranty.

This warranty does not cover claims, which do not involve defective workmanship or materials.

Damage to the SYSTEM caused by accident, misuse, abuse, or installation error, whether performed by a contractor, Service Company, or owner, is not covered by this warranty. Modification of the SKYTECH product will void this warranty.

IN NO EVENT SHALL SKYTECH BE LIABLE FOR INCIDENTAL AND CONSEQUENTIAL INCLUDING THE IMPLIED WARRANTIES OF MERCHANTABILITY AND FITNESS, ARE LIMITED TO THE DURATION OF THIS WRITTEN WARRANTY. THIS WARRANTY SUPERSEDES ALL OTHER ORAL OR WRITTEN WARRANTIES.

Some States do not allow the exclusion or limitation of incidental and consequential damages or limitation on how long an implied warranty lasts, so the above limitation may not apply to you. This warranty gives you specific rights and you may have other rights, which vary from state, province, and nation.

## How to Obtain Service:

Contact SKYTECH II or your SKYTECH Dealer direct with the following information:

- Name, Address, Telephone Number of Owner
- Date of Purchase, Proof of Purchase
- Model Name, Date Code
- Any relevant information or circumstances, e.g., installation, mode of operation when defect was noted.

Warranty claim process will start with all of this information. SKYTECH will reserve the right to physically inspect the product for defects, by authorized representatives.

---

Detach at this line for return to: Skytech II 9230 Conservation Way, Fort Wayne, IN 46809 Telephone: (888) 672-8929

Purchase Date: \_\_\_\_\_ Model: \_\_\_\_\_ Date Code: \_\_\_\_\_

Purchased From: \_\_\_\_\_ Date: \_\_\_\_\_

Customer Name \_\_\_\_\_ Number of Santa's Helpers \_\_\_\_\_

Address \_\_\_\_\_

City \_\_\_\_\_ State/Prov. \_\_\_\_\_ Zip/Postal Code \_\_\_\_\_

Credit Card Number \_\_\_\_\_ Expiring Date \_\_\_\_\_

(Visa and MasterCard Only) See other side for a special offer for all Remote control Customers

# Santa's Helper

## Exclusive offer to Skytech Remote Control Owners

This special offer is only provided to customers of Skytech II, Inc. that have purchased a remote control for their Hearth Product. This remote control system can be used for any 110Volt appliance, but perfect your Christmas Tree Lights or any other appliance that is difficult to reach or plug in. Simply plug the receiver into your wall outlet and your appliance into the receiver, push the ON button on the transmitter and you are in business. It's that easy.

Model **1310** \$29.95



# Santa's Helper

Santa's Helper is a unique and specialized device designed to save time and effort. Every Christmas brings the challenge of plugging in the lights on the tree. But this year can be different. Simply plug the remote directly into a standard 110 household electrical outlet and plug your light directly into the receiver. You can even use an extension cord for convenience. Then with a

simple push of the button on the transmitter, your lights are turned on and off with ease.

From as far away as 100 feet, the radio frequency controls only what is plugged into the receiver. With over 255 security codes, no other appliances will be affected. And best of all, you don't even have to point the remote at the receiver.

Features:

- 110 VAC - input
- 2 prong polarized plug
- 110 VAC - output
- 2 prong polarized receptacle
- 1000 Watts of rated power or 1/4 HP motor
- Transmitter is battery operated (12 Volt included)
- 255 Security Code
- 100 feet of Operational Distance
- All Radio Frequency
- UL and FCC Approved

[homeremotes.com](http://homeremotes.com)  888-672-8929 | 888-672-8024 (FAX)  
9230 CONSERVATION WAY | FORT WAYNE, INDIANA 46809

The list price of **\$29.95** for the Santa's Helper has been cut almost in half to **\$15.00 USD** for this exclusive offer. Shipping and handling of **\$5.00 USD** should be added. Send your check, money order or your Visa / MasterCard number, with Expiration Date to our office, along with the warranty information from your remote control for your Hearth Product. You can send this via mail, fax, or e-mail.

Skytech II, Inc.

9230 Conservation Way

Fort Wayne, IN 46809

1 (888) 672-8929

1 (888) 672-8024 Fax

[skytechsystem@fwin.net](mailto:skytechsystem@fwin.net) e-mail