

Selkirk® Chimney System (SCS)

The rugged all-fuel chimney designed for maximum safety and performance!

We Stand Behind Our Products.

Backing our commitment to quality, Selkirk All-Fuel Chimney Systems carry the "Smart Choice" Limited Lifetime Warranty. All system components (not just the insulated lengths) are warranted against defects in material and workmanship for the life of the product.

An impeccable safety record, along with unsurpassed durability, design and materials, all give us the confidence to offer a warranty this comprehensive and unmatched by anyone else in the industry.

For over 85 years we have been the industry's chimney innovator, using the highest in design standards to develop the safest products.

Safety

Our All-Fuel Chimney is listed to Underwriters Laboratories Safety Standard for Factory-Built Chimneys (UL-103).

ULTRA-TEMP® HT GALVA-TEMP® HT

Diameter Sizes: 5", 6", 7" & 8"
Part Identification: Letter UT and GT
Clearances: 2" of Airspace to Combustibles
Temperature Ratings: 2100°F (Maximum Test 10 min.)
1400°F (Maximum for 60 min.)
1000°F (Maximum Continuous Operating Temperatures)



ULTRA-TEMP® GALVA-TEMP®

Diameter Sizes: 10", 12", 14", 16", 18", 20", 22" & 24"
Part Identification: Letter U and G
Clearances: 2" of Airspace to Combustibles
Temperature Ratings: 1700°F (Maximum Test 10 min.)
1400°F (Maximum for 60 min.)
1000°F (Maximum Continuous Operating Temperatures)

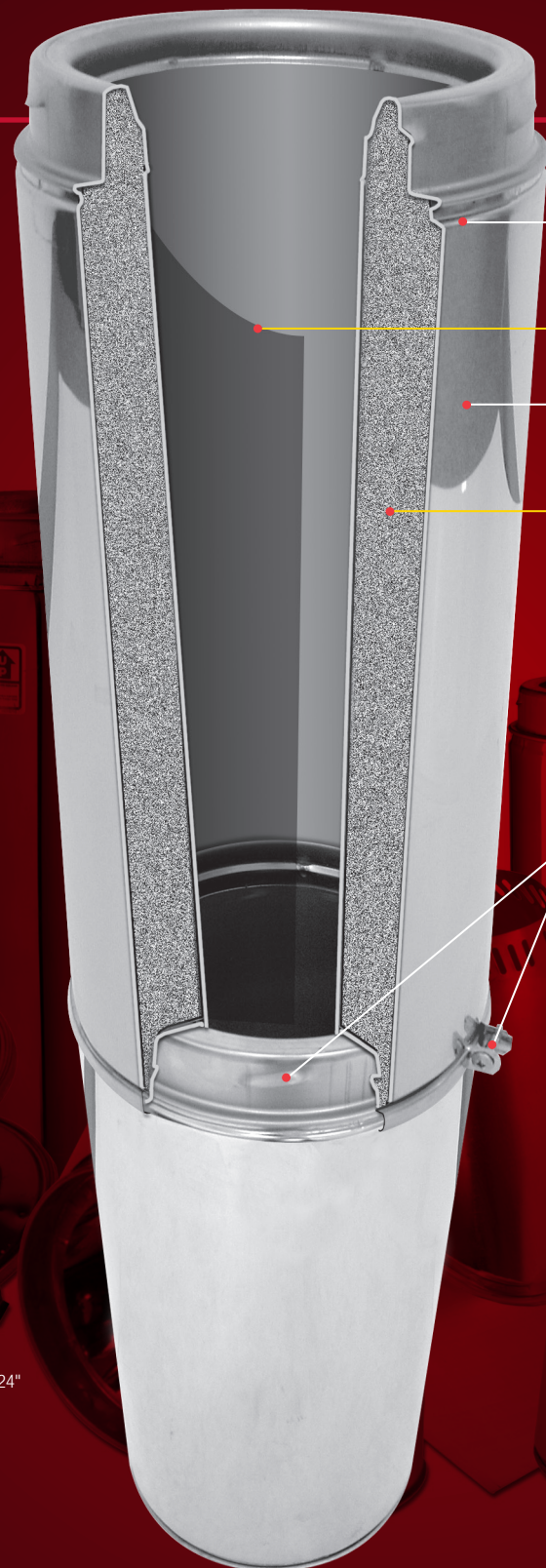

Ultra-Temp® - All-Stainless Steel
Galva-Temp® - Galvanized Exterior

5"-8" Type HT All-Fuel Chimney listed to UL103HT

304 Stainless Steel inner liner

Choice of Stainless Steel or Galvanized Steel outer casing

1" Solid Pack Insulation - Our proprietary Solid Pack Insulation helps maintain higher flue gas temperatures for superior drafting performance and lower outside temperatures for safety. Independent testing by Omni Labs shows Ultra-Temp Chimney is the coolest under the hottest conditions.*

Twist-Lock Coupler w/Locking Band included at no extra charge

Hard Tooled supports and accessories for the perfect fit every time

"Smart Choice" Lifetime Warranty



Professional installation qualifies for extended coverage - see warranty for details.

*UL103HT Chimney independently tested by Omni-Test Laboratories, Inc.

Get the Selkirk® Advantage...

The tradition continues... Selkirk is the original innovator of prefabricated Venting systems – and we continue to move forward. Count on Selkirk, the world's most recognizable name in Chimney & Venting, for the widest range of high-performance products to meet your needs.

Selkirk Corporation
5030 Corporate Exchange Blvd. SE
Grand Rapids, MI 49512
1.800.433.6341

Selkirk Canada Corporation
950 South Service Road
Second Floor
Stoney Creek, ON L8E 6A2
1.888.SELKIRK (735.5475)
Toll Free Fax: 1.866.835.9624



www.selkirkcorp.com

MBAFCBG 10/19



All-Fuel Chimney Buyers Guide



Ultra-Temp®
All-Stainless Steel

Galva-Temp®
Galvanized Exterior



Selkirk Chimney Systems
"The Coolest Under the Hottest Conditions..."



Selkirk® Chimney System (SCS) Insulated Pipe and Accessories

The rugged all-fuel chimney designed for maximum safety and performance!

Insulated Pipe (5", 6", 7" & 8" I.D.; 6", 9", 12", 18", 24", 36" & 48" Lengths)



Adjustable Insulated Pipe (T-AIP)



Insulated Tee & Plug (T-IT)



Insulated Elbow Kits
15° - (T-EL15)
30° - (T-EL30)



Thru-The-Wall Support Kit*

Flat Ceiling Support Kit*

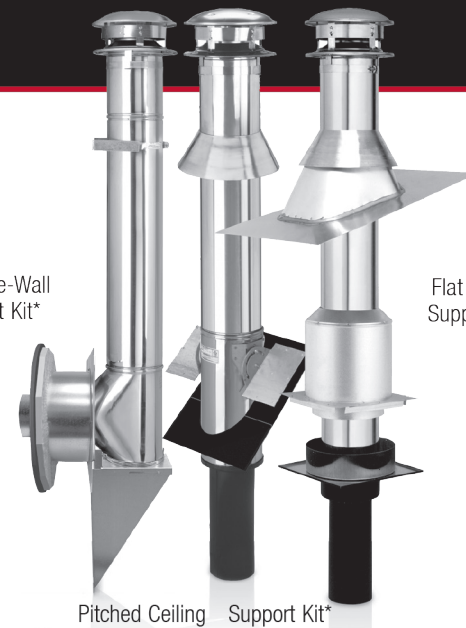

* Chimney lengths are not included in kits, except the Thru-The-Wall kit contains a T-12 for the horizontal run and the Pitched Ceiling kit contains a Roof Support attached to a T-18.

Wall Support Kit (T-WSK)

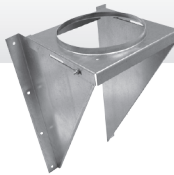

Finish Support Package (T-FSP)



Finish Support Package Round (T-FSPR)



Anchor Plate (T-AP)



Roof Support Package (T-RSP)



Support Box (T-SB)



Interior Resupport (T-IR)



Round Top (T-CT)

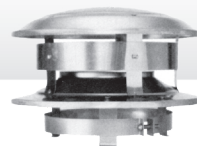

Storm Collar (T-SC)

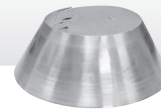

Adjustable Flashing (T-AF6) (T-AF12)

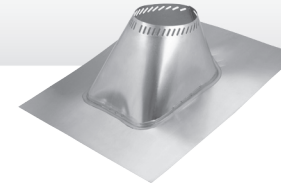

Rubber Boot Flashing Kit (URBAK)

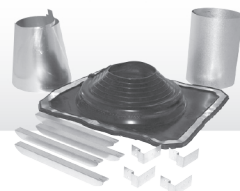

Insulated Wall Thimble (T-WT)

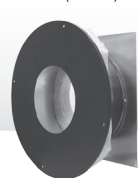

Attic Insulation Shield (T-AIS)



Fire Stop/Joist Shield (JS)



Dripless Stove Pipe Adapter W/Coupler (T-DSAC)



Dripless Stove Pipe Adapter (T-DSA)



Roof Brace Kit (T-RBK) Heavy Duty (HDRBK) Roof Brace Kit



Wall Band (T-WB)



Adjustable Pitched Ceiling Plate (T-PCPAJ)



Finish Collar (T-FC)



Trim Plate (T-PS)

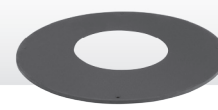

SUSI Insulation



PIPE DIAMETER (choose one):	5"	6"	7"	8"	U=Ultra Temp.	G=Galva Temp.	ITEM	PRODUCT CODE	QUANTITY	PRICE
INSULATED CHIMNEY PIPE										
							6" LENGTH (T6)	20X006U or 20X006G		
							9" LENGTH (T9)	20X009U or 20X009G		
							12" LENGTH (T12)	20X012U or 20X012G		
							18" LENGTH (T18)	20X018U or 20X018G		
							24" LENGTH (T24)	20X024U or 20X024G		
							36" LENGTH (T36)	20X036U or 20X036G		
							48" LENGTH (T48)	20X048U or 20X048G		
							ADJ. INSULATED PIPE (T-AIP)	20X011U		
							INSULATED TEE (T-IT)	20X100 or 20X100G		
							15° INSULATED ELBOW KIT (T-EL15)*	20X206 or 20X206G		
							30° INSULATED ELBOW KIT (T-EL30)*	20X211 or 20X211G		
							WALL SUPPORT KIT (T-WSK)	20X430		
							FINISH SUPPORT**	20X410(FSP) or 20X411(FSPR)		
							ANCHOR PLATE (T-AP)	20X400		
							ROOF SUPPORT (T-RSP)	20X420 or 20X420G		
							SUPPORT BOX (T-SB)	20X424		
							INTERIOR RESUPPORT	20X435		
							ROUND TOP (T-CT)	20X800		
							STORM COLLAR (T-SC)	20X810		
							ADJUSTABLE FLASHING (T-AF6)	20X825		
							2/12 TO 6/12			
							ADJUSTABLE FLASHING (T-AF 12)	20X830		
							6/12 TO 12/12			
							RUBBER BOOT FLASHING KIT (T-TF)	200275		
							ATTIC INSULATION SHIELD (T-AIS)	20X490		
							INSULATED WALL THIMBLE (T-IWT)	20X463		
							FIRE STOP/JOIST SHIELD (T-JS)	20X465		
							DRIPLESS SMOKE PIPE ADAPTER WITH COUPLER (T-DSAC)	20X240		
							DRIPLESS SMOKE PIPE ADAPTER (T-DSA)	20X242		
							CHIMNEY PIPE ADAPTER	25X240		
							ROOF BRACE KIT (T-RBK or HDRBK)	20X440(RBK) or 0843900(HDRBK)		
							WALL BAND (T-WB)	20X520		
							ADJ. PITCHED CEILING PLATE 0/12-6/12 (T-PCPAJ)	20X512		
							ADJ. PITCHED CEILING PLATE 6/12-12/12 (T-PCPAJ12)	20X514		
							FINISH COLLAR (T-FC)	20X480		
							TRIM PLATE (T-PS)	20X488		
							SUSI INSULATION (SUS)	2000001		
							TOTAL			

*2 Elbows, 2 Locking Bands, 1 Interior Resupport and Couplers
**(T-FSP) SQUARE (T-FSPR) ROUND

For a complete product catalog, order All Fuel Catalog #MBAFC00-E.

CHIMNEY KITS

ITEM	PRODUCT CODE	QUANTITY	PRICE
Roof Termination Kit (CT, AF6 & SC)	20X600		
Flat Ceiling Support Kit (CT, AIS, SC, FSP, AF6 & DSAC)	20X620		
Pitched Ceiling Support Kit (CT, SC, FC, RSP, DSAC & PCPAJ)	20X621 or 20X621G		
THRU-THE-WALL SUPPORT KIT (CT, WB, IT, FC, WSK, IWT, CPA & T-12)	20X622 or 20X622G		

DSP – DOUBLE WALL STOVE PIPE Available in 6", 7", 8"

PIPE DIAMETER (choose one):	6"	7"	8"	ITEM	PRODUCT CODE	QUANTITY	PRICE
Vertical Installation Kit, Includes							
				Telescoping length 39"-66"	DSPXTL		
				36" Length	DSPXP36-1		
				24" Length	DSPXP24-1		
				12" Length	DSPXP12-1		
				12" Adjustable Length	DSPXAL-1		
				90° Elbow	DSPXE9-1		
				45° Elbow	DSPXE4-1		
				Tee with Insulated Cap	DSPXTE-1		
				Chimney Pipe Adapter	XT-CPA		

We carry a full line of increasers and decreasers to fit 6", 7" and 8" diameters.
For a complete product catalog, order Stove Pipe Catalog #DSP002-E.

Fuels and Appliances

Ultra-Temp and Galva-Temp (SCS) systems are certified to UL103HT for All-Fuel Chimney systems in sizes 5", 6", 7" and 8". These Type A-Vent Chimneys have been tested, listed and certified to meet the 2100 degree safety standard by Underwriters Laboratories. Sizes 10"-24" Type A-Vent Chimneys have been tested, listed and certified to UL103 (1700 degree) safety standard by Underwriters Laboratories.

A System for Every Installation

The SCS includes a variety of components to meet every installation requirement. These components may be combined in a wide variety of ways to solve almost any chimney installation problem. For additional information on part selection, refer to the guide pages and diagrams located in this catalog.

Complete Product Information

The Ultra-Temp and Galva-Temp (SCS) product lines are supported by the website at www.selkirkcorp.com. Visit our site for product catalogs, installation instructions and web-based tools, including an On-Line Chimney Planner, Dealer Locator, Selkirk University On-Line Training and more.