

MAJESTIC

Please consult the manufacturer's installation manual for all details and requirements before making a final design layout decision.

REVEAL RBV4236
B-Vent Gas Fireplace

MODEL	FRONT WIDTH		BACK WIDTH		HEIGHT		DEPTH		VIEWING AREA
	Actual	Framing	Actual	Framing	Actual	Framing	Actual	Framing	
RBV4236	41	42	23-3/4	42	39-1/2	39-3/4	21-1/2	22	36 x 21

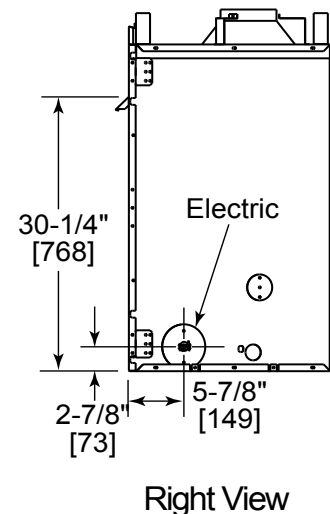
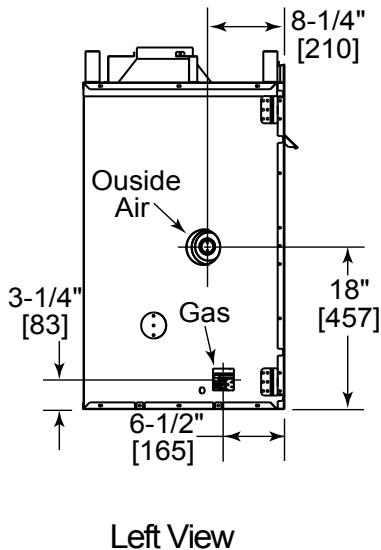
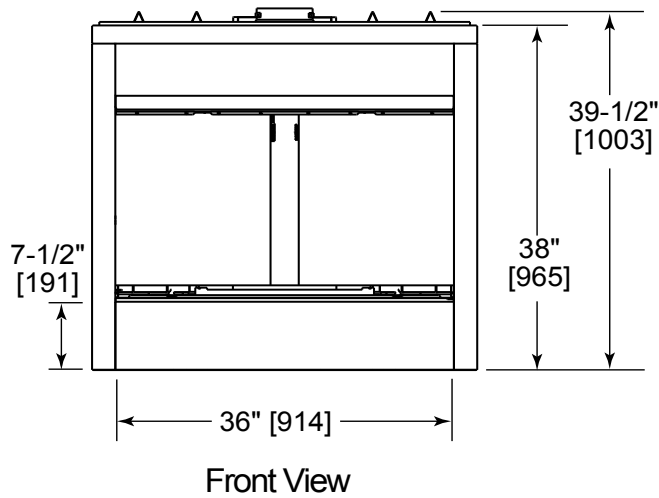
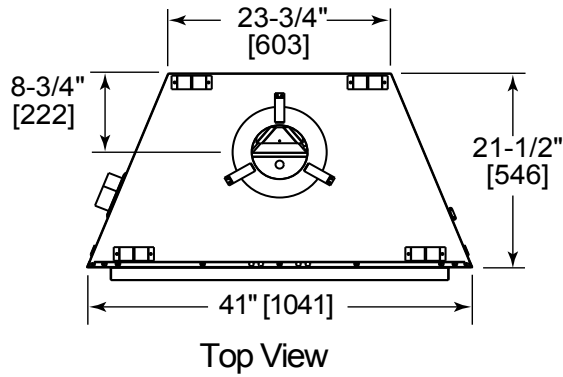

MINIMUM FIREPLACE CLEARANCES

AREA	TO COMBUSTIBLES (in inches)
CLEARANCE TO CEILING	30
COMBUSTIBLE/NON-COMBUSTIBLE FLOOR	0
SIDES OF APPLIANCE	0
FRONT OF APPLIANCE	36

APPLIANCE LOCATION

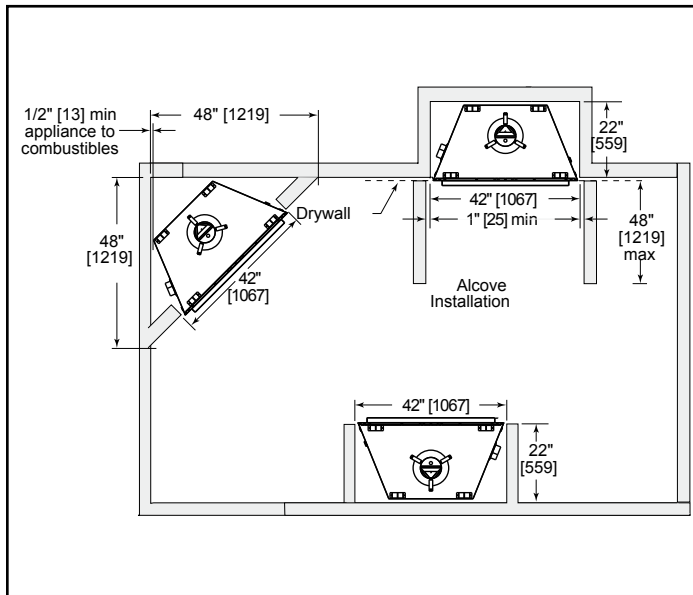

MANTEL PROJECTIONS

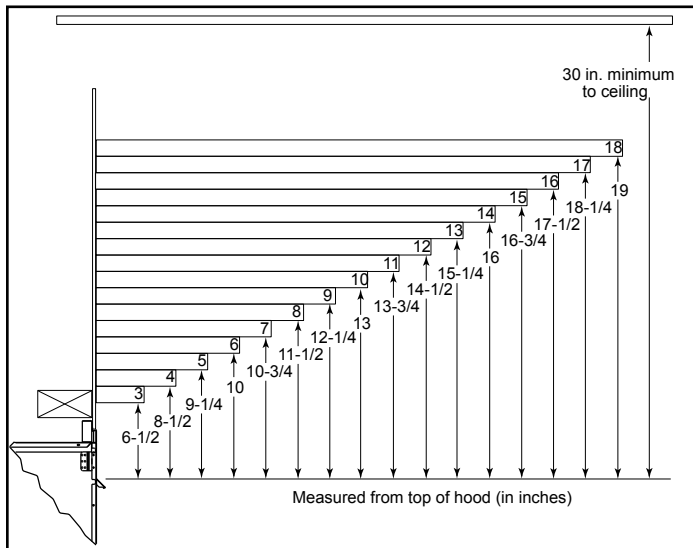

FRAMING DIMENSIONS

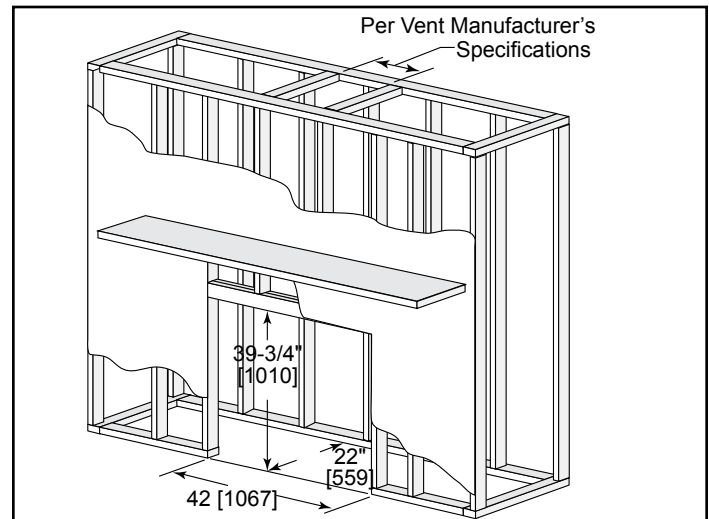

CLEARANCES TO COMBUSTIBLES

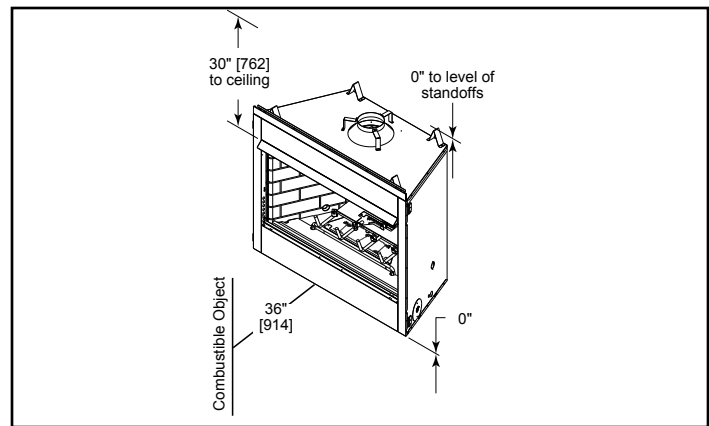

MANTEL LEG/WALL PROJECTIONS

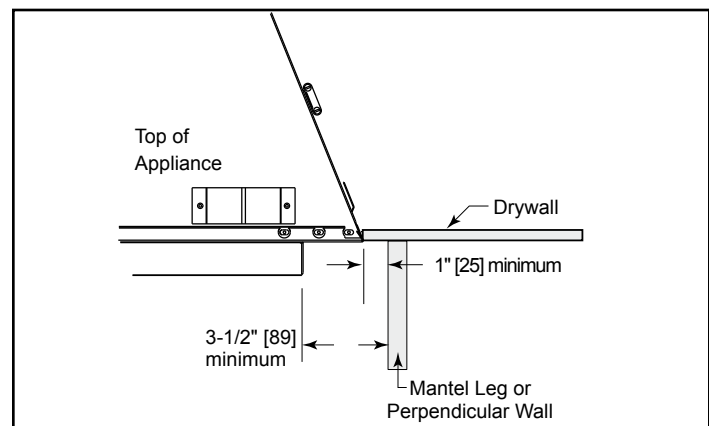

PRODUCT LISTING CODES	
US	ANSI Z21.50a-2008
CAN	CSA 2.22a-2008
US LISTED	UL307B

Product information provided is not complete and is subject to change without notice. Product installation must adhere strictly to instructions accompanying product to avoid risk of fire and potential injury.

Additional information can be found online at www.majesticproducts.com