

MAJESTIC

Please consult the manufacturer's installation manual for all details and requirements before making a final design layout decision.

MARQUIS II 36
Direct Vent Gas Fireplace

MODEL	HEIGHT		FRONT WIDTH		BACK WIDTH		DEPTH		GLASS SIZE
	ACTUAL	FRAMING	ACTUAL	FRAMING	ACTUAL	FRAMING	ACTUAL	FRAMING	
MARQ36 44,000 BTU (NG) 43,500 BTU (LP)	57-5/8" [1464]	56" [1422]	61" [1549]	59-1/2" [1511]	59-1/4" [1505]	59-1/2" [1511]	24" [610]	24" [610]	35-7/8" x 31-1/16" [911 X 789]

TOP VIEW

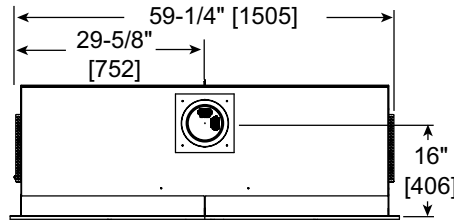

LEFT SIDE

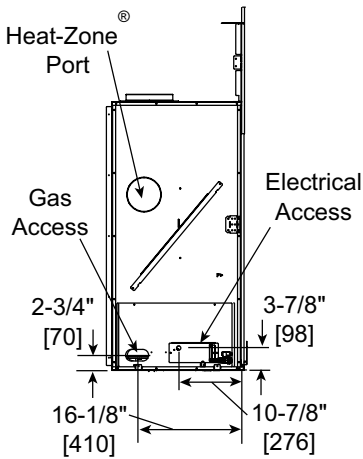

FRONT VIEW

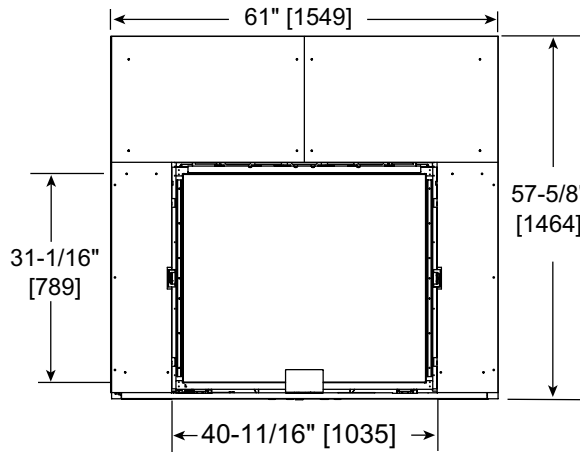

RIGHT SIDE

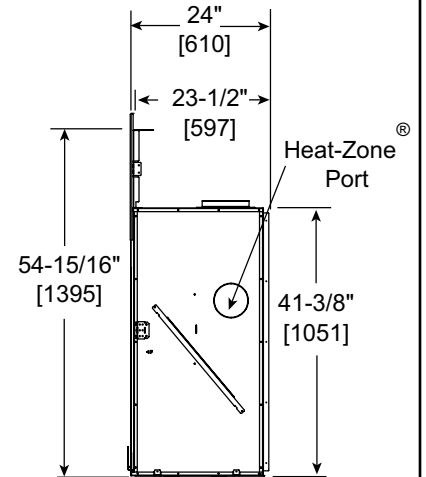

DECORATIVE FRONT

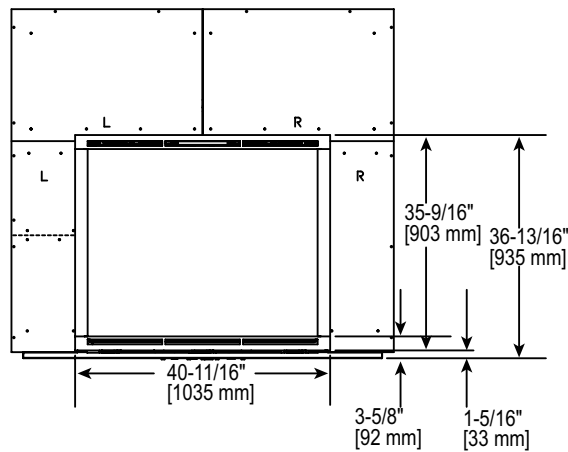

APPLIANCE LOCATION

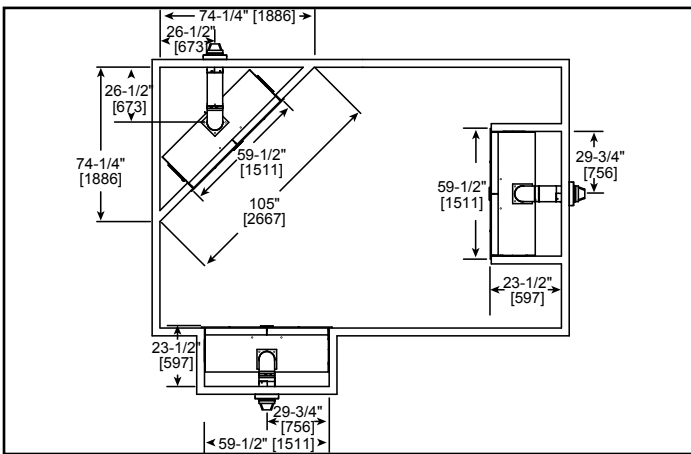

WALL PENETRATION

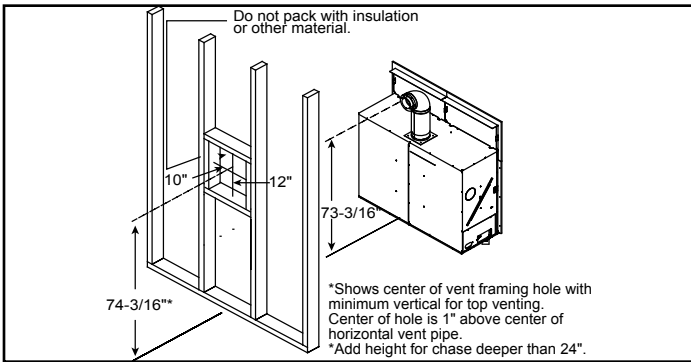

MANTEL LEG/WALL PROJECTIONS

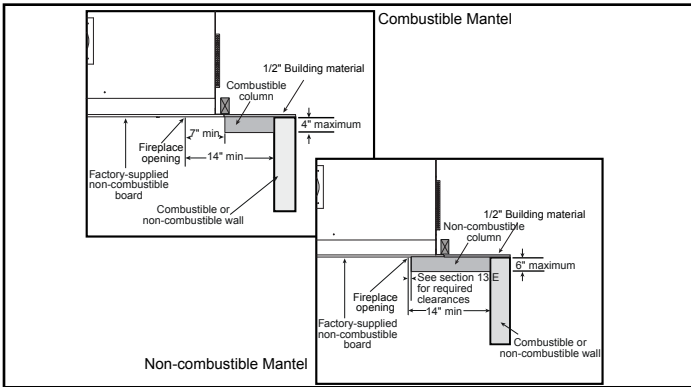

MANTEL PROJECTIONS

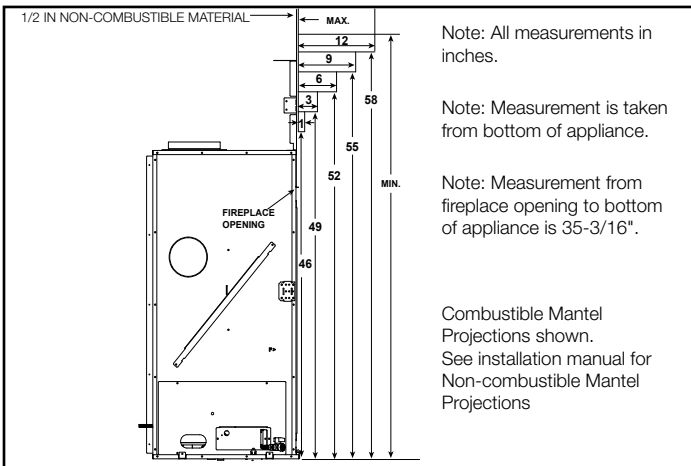

FRAMING DIMENSIONS

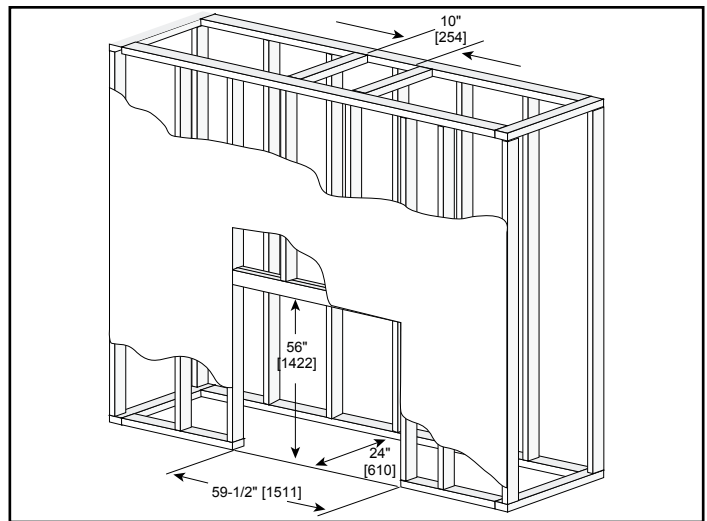

CLEARANCES TO COMBUSTIBLES

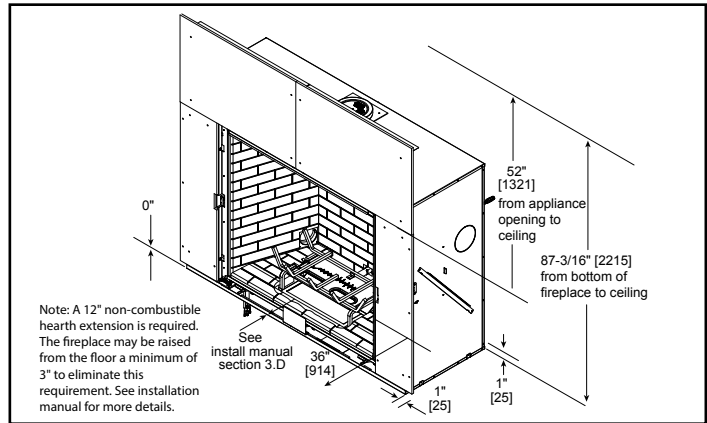

NON-COMBUSTIBLE ZONE

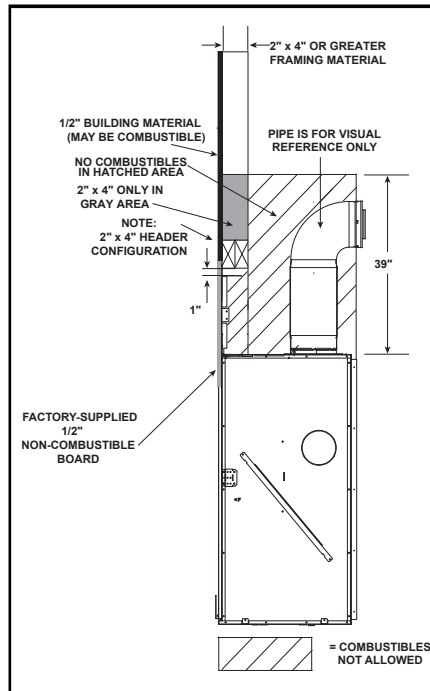

PRODUCT LISTING CODES	
US	ANSI Z21.88-2017
CAN	CSA 2.33-2017
UL LISTED	UL307B

Product information provided is not complete and is subject to change without notice. Product installation must adhere strictly to instructions accompanying product to avoid risk of fire and potential injury.