

# INSTALLATION AND OPERATION GUIDE FOR HARGROVE VENT FREE GAS LOGS

## COAL BASKET



We recommend that our gas hearth products be installed and serviced by professionals who are certified in the U.S. by the National Fireplace Institute® (NFI) as NFI Gas Specialists.

DESIGN CERTIFIED to  
UNVENTED – ANSI Z21.11.2  
VENTED - ANSI Z21.60/CGA 2.26



Installation and service must be provided by a qualified installer, service agency or the gas supplier.

**NOTE:** ADEQUATE FIREPLACE VENTILATION IS REQUIRED FOR SAFETY.  
READ INSTRUCTIONS FULLY BEFORE INSTALLING OR OPERATING.  
**INSTALLER:** LEAVE THIS MANUAL WITH THE APPLIANCE.  
**CONSUMER:** RETAIN THIS MANUAL FOR FUTURE REFERENCE.

### **WARNING:**

If the information in this manual is not followed exactly, a fire or explosion may result, causing property damage, personal injury, or loss of life.

### **WHAT TO DO IF YOU SMELL GAS**

1. Open a window.
2. Do not try to light any appliance.
3. Do not touch any electrical switch; do not use the phone in your building.
4. Immediately call your gas supplier from a neighbor's phone. Follow the gas supplier's instructions.
5. If you cannot reach your gas supplier, call the fire department.

### **FOR YOUR SAFETY**

Do not store or use gasoline or other flammable vapors and liquids in the vicinity of this or any other appliance.

### **IMPORTANT:**

Installation and service must be performed by a qualified professional installer, service agency, or the gas supplier. Improper installation, adjustments, alteration, service, or maintenance can cause personal injury or property damage. Refer to this manual.

This appliance operates as an unvented room heater when fitted to a solid fuel burning masonry fireplace or UL 127 approved factory built fireplace with the flue damper closed. It may also be installed in an approved unvented fireplace.

### **WARNING:**

**THIS IS AN UNVENTED GAS FIRED HEATER. IT USES AIR (OXYGEN) FROM THE ROOM IN WHICH IT IS INSTALLED. PROVISIONS FOR ADEQUATE COMBUSTION AND VENTILATION AIR MUST BE PROVIDED. REFERENCE FUEL GAS CODE NFPA 54, ANSI Z223.1 REFER TO PAGE 2 OF THE INSTALLATION INSTRUCTIONS.**

This appliance is designed to supplement a current heating system. It is not designed to be used as a primary heat source.

### **NOTE:**

This appliance is only for use with the type of gas indicated on the rating plate. This appliance is not convertible for use with other gases. Solid-fuels shall not be burned in a fireplace where a decorative appliance is installed.

## IMPORTANT PRE-INSTALLATION AND FIREPLACE SAFETY INFORMATION

**To determine the safest and most efficient location for your Vent Free Fireplace, you must take into consideration the following guidelines.**

1. This appliance operates as an unvented room heater certified under ANSI Z21.11.2a when fitted to a masonry or factory built fireplace with the flue damper open or closed. It may also be installed in approved vent free fireplace. If installing in an approved vent free firebox, refer to their instruction guide for proper installation. Solid fuels shall not be burned in a fireplace where an unvented room heater is installed.
2. Do not use a natural gas set for propane or a propane set for natural gas. If the gas type is not correct. **DO NOT INSTALL.** Contact your dealer for immediate assistance. Any change to this heater or its controls can be dangerous.
3. Gas log sets must be installed by personnel qualified for installing gas appliances.
4. The location must allow for proper clearances for accessibility of servicing and proper operation (see section on Fireplace Clearances – page 4).
5. Consider a location where heat output would not be affected by drafts, air conditioning ducts, windows or doors. Do not allow fans to blow directly into the fireplace, avoid any drafts that alter burner flame patterns.
6. Inspect area surrounding the location chosen for the fireplace for possible air drafts that may affect the flames and possibly cause sooting. Air drafts may be caused by a ceiling fan near the fireplace, a hot furnace or an open door.
7. Due to high temperatures, the appliance should be located out of traffic and away from furniture and draperies. Young children should be carefully supervised when they are in the same room with the appliance. It is recommended that adults be present when this gas appliance is operating. It is recommended that this unit is not left burning when unattended or while anyone is sleeping.
8. Children and adults should be alerted to the hazards of high surface temperatures and should stay away to avoid burns or clothing ignition.
9. Install in an area providing adequate combustion and ventilation air (see section on adequate combustion and ventilation air requirements – page 2).
10. Do not install in a building that is of unusually tight construction. Unusually tight construction is defined as construction where:
  - a. Walls and ceiling exposed to the outside atmosphere have a continuous wall vapor retarder with a rating of 1 perm or less with openings gasketed or sealed, and
  - b. Weather stripping has been added on openable windows and doors, and
  - c. Caulking or sealants are applied to areas such as joints around window and door frames, between sole plates and floors, between wall-ceiling joints, between wall panels, at penetration for plumbing, electrical and gas lines and at other openings.
11. Do not install this heater in bedrooms, bathrooms or recreational vehicles.
12. This appliance may be installed in an aftermarket manufactured (mobile) home, where not prohibited by state or local codes.
13. Maintain adequate clearances around air openings.
14. When glass fireplace doors are used, always operate gas log set with the doors fully open to allow for proper combustion air and to keep control valves from overheating.
15. Keep appliance area clear and free from combustible materials, gasoline and other flammable vapors and liquids. Do not allow clothing or flammable materials on or near the fireplace. The flame in this appliance is not isolated from the air space it heats and it will ignite flammable vapors, dust particles or other combustible materials that come in contact with it which can result in an explosion or fire.

# PREINSTALLATION REUIREMENTS

## COMBUSTION AND VENTILATION AIR REQUIREMENT WORKSHEET

**WARNING:** IF THE AREA IN WHICH THE HEATER MAY BE OPERATED IS SMALLER THAN THAT DEFINED AS UNCONFINED SPACE OR IF THE BUILDING IS OF UNUSUALLY TIGHT CONSTRUCTION, PROVIDE ADEQUATE COMBUSTION AND VENTILATION AIR BY ONE OF THE METHODS DESCRIBED IN THE NATIONAL FUEL GAS CODE, ANSI Z223.1 SECTION 5.3 OR APPLICABLE LOCAL CODES.

This heater shall not be installed in a confined space or unusually tight construction unless provisions are provided for adequate combustion and ventilation air.

The following formula can be used to determine the maximum BTU rating per the definition of unconfined space:

**STEP ONE:** DETERMINE THE VOLUME OF SPACE IN CUBIC FEET.

LENGTH X WIDTH X HEIGHT = \_\_\_\_\_ cu. Ft.  
(Include adjoining rooms with doorless passageways or ventilation grills between rooms.)

Example: 24' (L) X 16' (W) X 8' (H) = 3,072. cu. Ft.

**STEP TWO:** MULTIPLY THE VOLUME OF SPACE BY 20 BTU/Hr. TO DETERMINE THE MAXIMUM BTU/Hr. THE SPACE CAN SUPPORT.

Example: 3,072 cu. Ft. X 20 BTU/Hr. = 61,440 BTU/Hr.  
(Maximum BTU/Hr. the room can support)

**STEP THREE:** ADD THE BTU/Hr. OF ALL THE FUEL BURNING APPLIANCES IN THE SPACE.

VENT FREE HEATER \_\_\_\_\_ BTU/Hr.

GAS APPLIANCE #1 \_\_\_\_\_ BTU/Hr.

GAS APPLIANCE #2 \_\_\_\_\_ BTU/Hr.

Example:        VENT FREE HEATER    26,000 BTU/Hr.  
                      GAS APPLIANCE #1    35,000 BTU/Hr.  
    TOTAL 61,000 BTU/Hr.

**NOTE: DO NOT INCLUDE DIRECT-VENT GAS APPLIANCES. DIRECT VENT IS SEALED COMBUSTION AND DRAWS COMBUSTION AIR FROM THE OUTDOORS.**

THE SPACE IN THE ABOVE EXAMPLE IS AN UNCONFINED SPACE BECAUSE THE 61,000 BTU'S AN HOUR USAGE IS LESS THAN THE 61,440 BTU'S AN HOUR AVAILABLE. IF THE TOTAL BTU'S AN HOUR USAGE IS GREATER THAN 61,440 BTU'S AN HOUR THEN THE SPACE WOULD BE A CONFINED SPACE AND ADDITIONAL AIR MUST BE PROVIDED.

The National Fuel Gas Code defines a confined space as a space whose volume is less than 50 cubic feet per 1,000 BTU per hour (4.8 m<sup>3</sup> per kw) of the aggregate input rating of all appliances installed in that space and unconfined space as a space whose volume is not less than 50 cubic feet per 1,000 BTU per hour (4.8 m<sup>3</sup> per kw) of the aggregate input rating of all appliances installed in that space. Rooms communicating directly with the space in which the appliances are installed, through openings not furnished with doors, are considered a part of the unconfined space.

# PREINSTALLATION SPECIFICATIONS

## BTU RATINGS AND PRESSURE REQUIREMENTS

LOG SET SIZE	Natural Gas	Liquid Propane
<b>MAX. HEAT INPUT</b>	20,000 BTU	20,000 BTU
<b>GAS INLET PRESSURE</b>		
<b>MAX.</b>	10.5" WC	13" WC
<b>MIN.</b>	5" WC	11" WC
<b>REGULATOR PRESSURE</b>	4" WC	10" WC

When operating the main burner, use the control knob to raise and lower the min. and max. heat output. Turn the control knob counterclockwise for max. heat and clockwise for min heat.

Input ratings are shown in BTU per hour and are for elevations up to 2,000 feet. For elevations above 2,000 feet, input ratings should be reduced 4% for each 1,000 feet above sea level. Refer to the National Fuel Gas Code.

**WARNING:** OPERATION OF THIS APPLIANCE ON GASES FOR WHICH IT IS NOT EQUIPPED MAY LEAD TO CARBON MONOXIDE POISONING.

## FIREPLACE DIMENSIONS AND CLEARANCES

Refer to the following charts to determine the proper size set for your fireplace.

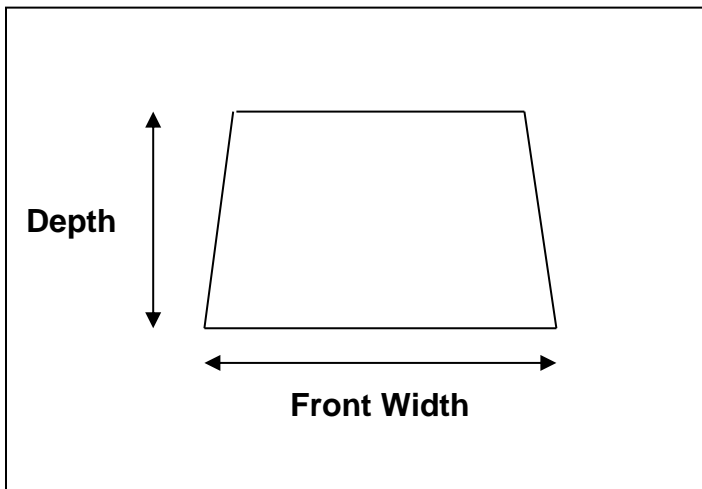

Log Set Size	Fireplace Dimensions		
	Depth	Height	Front Width
19"	10"	16"	22"

The chart above indicates the minimum fireplace dimensions for each log set.

# PREINSTALLATION SPECIFICATIONS

## MINIMUM CLEARANCES TO COMBUSTIBLE MATERIALS AND MANTLE CLEARANCES

**IMPORTANT:** To insure a safe installation into a masonry or factory built fireplace, the following instructions must be carefully observed. If installing in a pre-manufactured fireplace follow the clearance requirements accompanying that fireplace.

**Refer to Fig. 1 for the following dimensions:**

- A. Minimum left and right clearance to combustible walls = 15".
- B. Minimum clearance to combustible ceiling = 42".
- C. Minimum left and right side clearances to mantle = 6".

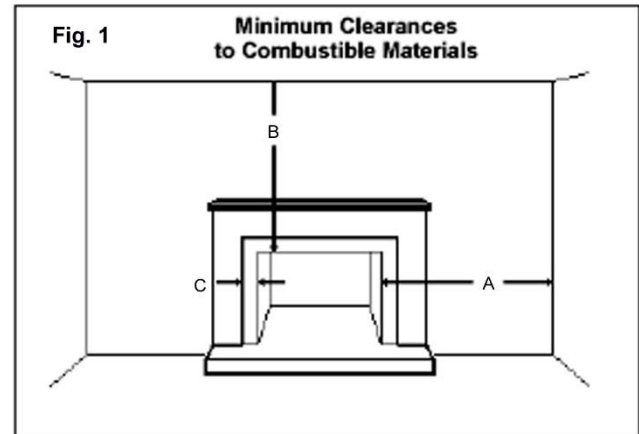

**Note:** Clearances to Combustible Materials and Mantle Clearances are in place to provide adequate spacing to prevent a fireplace mantle or facing from catching fire. In most cases they should also be adequate to prevent any discoloration or warping due to heat. However, each Gas Log installation will present unique circumstances creating many variables beyond the control of the Gas Log Manufacturer, including paint or finish composition, previous heat exposure, quality of construction, air flow patterns etc. Because of these variables we cannot guarantee that heat warping or discoloration will never occur. The possibility of heat damage exists whether burning wood or gas logs.

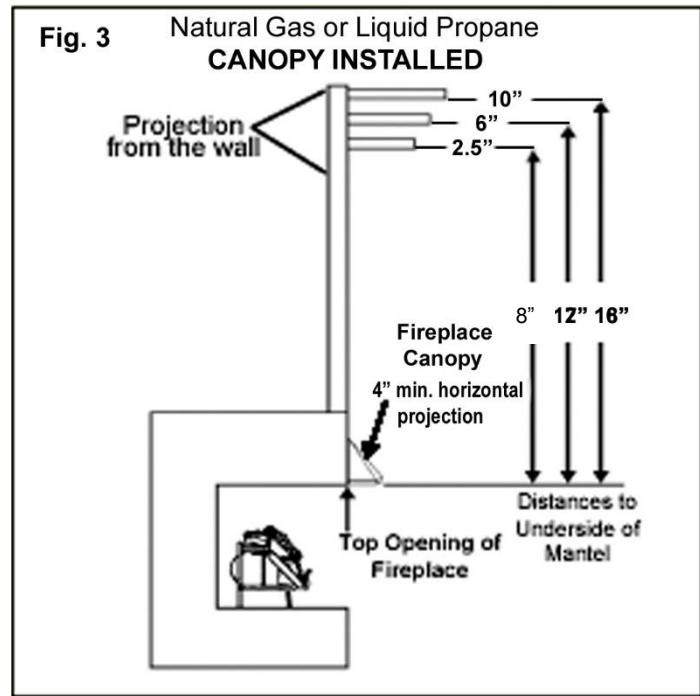
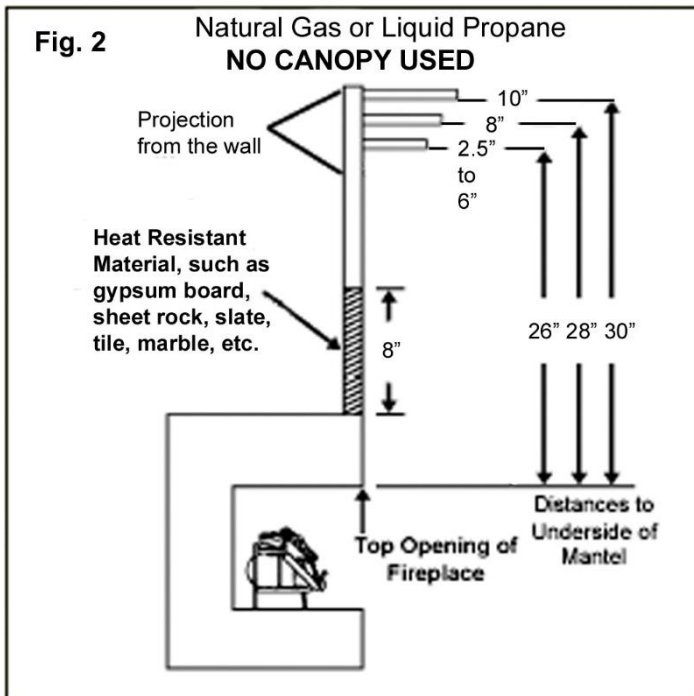

**IMPORTANT:** Woodwork such as mantles and other combustible material must be installed as tested per Fig 2 or Fig 3. Heat resistant material are materials such as gypsum board, sheetrock, slate, tile marble etc. If the mantle and wall are both non-combustible, mantle clearances are not applicable.

**NOTE:** A hood (canopy) as shown in Fig 3 is used to deflect heat away from the fireplace face and mantle, reducing the chances of heat damage or discoloration. If using a hood, it must project a minimum of 4" from the face of the firebox. Contact your dealer to purchase a fireplace hood.

## PREINSTALLATION CHECKLIST

**INSTALLER: Please leave these instructions with the homeowner.**

**HOMEOWNER: Please retain these instructions for future reference.**

State or local codes may only allow operation of this unit in a vented application. Check your state and local codes.

All Hargrove vent free room heaters comply with IAS U.S. Requirement 5-95.

The installation must conform with state and local codes or, in absence of local codes, to the National Fuel Gas Code, ANSI Z223.1

## FIREPLACE PREPARATION

**IMPORTANT:** Before installing in a solid fuel-burning fireplace, the chimney flue and firebox must be cleaned of soot, creosote, ashes, and loose paint by a qualified chimney cleaner.

1. Turn the gas supply to OFF.
2. Turn OFF all electrical power to blower (if applicable) before installing, servicing, or removing.
3. Clean the fireplace floor, walls, and chimney (if used) of any ashes, soot creosote, obstruction. *This will minimize any smell from the fireplace. We recommend cleaning by a chimney sweep.*
4. Any outside air ducts and/or ash dumps in the fireplace must be permanently closed at the time of appliance installation.
5. A mesh fireplace screen must be in place when the appliance is operating unless other provision for combustion air are provided, the screen shall have an opening(s) for introduction of combustion air.

**This unit complies with 527 CMR 30.00 vent free appliance requirements for Massachusetts.**

## INSTALLATION

**NOTE:** Before you proceed, make sure your gas supply is OFF!

**Check Gas Type:** The gas supply must be the same as stated on the heater's rating plate. If the gas supply is different, DO NOT INSTALL the heater. Contact your dealer for the correct model.

**IMPORTANT:** This appliance cannot be used with or converted to a gas other than the type for which it was equipped at the factory.

**WARNING:** OPERATION OF THIS APPLIANCE ON GASES FOR WHICH IT IS NOT EQUIPPED MAY LEAD TO CARBON MONOXIDE POISONING.

**This product must be installed by a licensed plumber or gasfitter when installed within the Commonwealth of Massachusetts.**

**WARNING:** CONNECTING DIRECTLY TO AN UN-REGULATED L.P. TANK CAN CAUSE AN EXPLOSION.

## GAS CONNECTION

**WARNING:** ANY MODIFICATION TO THIS UNVENTED GAS HEATER OR ITS CONTROLS CAN BE DANGEROUS. IMPROPER INSTALLATION OR USE OF THE HEATER CAN CAUSE SERIOUS INJURY OR DEATH FROM FIRE, BURNS, EXPLOSION OR CARBON MONOXIDE POISONING.

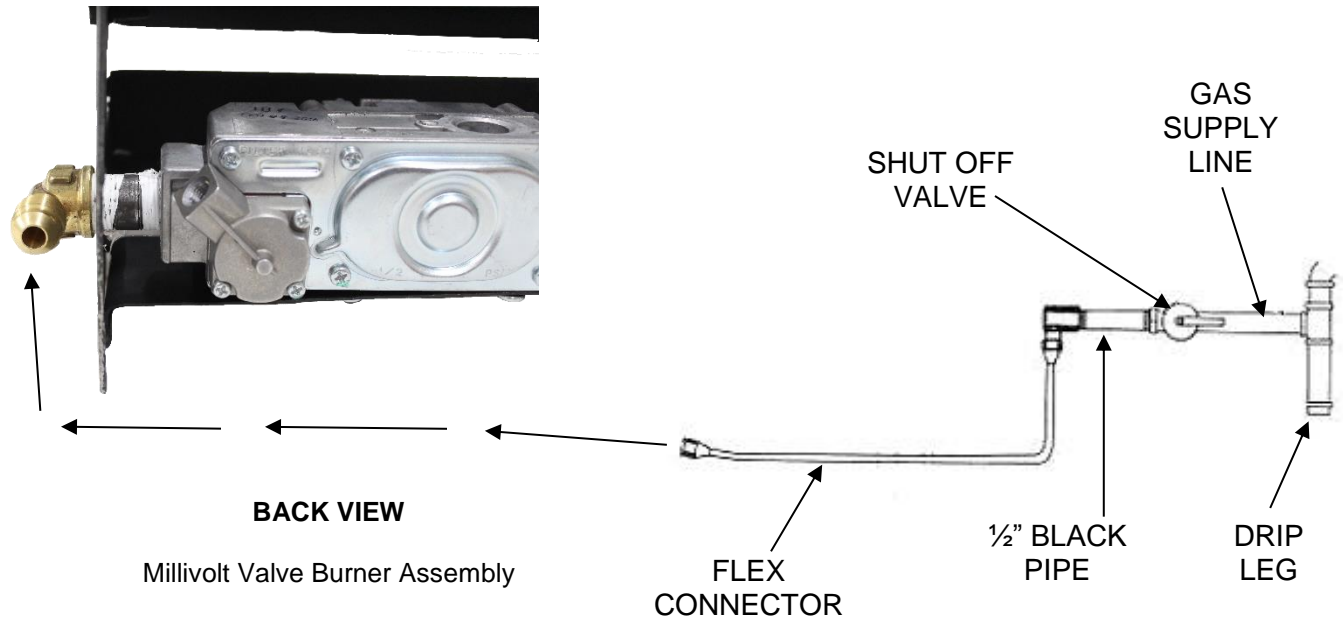

### IMPORTANT STEPS TO FOLLOW WHEN MAKING THE GAS LINE CONNECTION

1. Consult your gas supplier for proper gas pipe sizing. Normally up to 50' of 1/2" inside diameter (ID) gas pipe will supply adequate volume for all vent free units.
2. The incoming gas line may be routed into the fireplace either from the left or right side.
3. Include a manual shutoff valve in the gas supply line so the appliance may be disconnected for servicing.
4. Center the burner system from side to side in the firebox. In a vented firebox, if the damper is used, the burner assembly should be located directly under the damper.
5. Use the 3/8" flex connector (provided in the accessory kit) to connect the gas supply line to the regulator on the burner assembly.
6. Always use an external regulator for all L.P. appliances to reduce the supply tank pressure to a maximum of 13" W.C. This is in addition to the regulator fitted to the heater.
7. Test all connections after turning gas supply on for leaks using a soap and water solution. **DO NOT USE AN OPEN FLAME FOR LEAK TESTING.**
8. It is most convenient to light the pilot and check the operation of the main burner with the logs not in place. After carefully checking the gas supply line for leaks and correcting any found, refer to the "LIGHTING INSTRUCTIONS" section to test the burner assembly.

**WARNING:** DO NOT USE A BLOWER INSERT, HEAT EXCHANGER INSERT OR OTHER ACCESSORY NOT APPROVED FOR USE WITH THIS HEATER.

## GAS PRESSURE CHECK

**NOTE:** The appliance and the appliance main gas valve must be disconnected from the gas supply system during any pressure testing of that system at test pressures in excess of 0.5 psig (3.5 kPa). The appliance must be isolated from the gas supply piping system by closing its equipment shut-off valve during any pressure testing of the gas supply piping system at test pressures equal to or less than 0.5 psig (3.5 kPa).

1. The gas valve controls the gas pressure, which can be checked at the pressure test point (1/8" NPT plug) located on the side of the valve (see schematic below).
2. The pressure should be checked with the heater burner and the control set to high (HI).
3. The pressure is preset and locked to avoid tampering. If the pressure is not as specified in "BTU Rating and Pressure Requirements" (pg. 3), contact your dealer.
4. Replace the test plug after measuring gas pressure. Check for gas leaks.

**IMPORTANT:** Do not use the appliance if any part has been submerged under water. Immediately call a qualified technician to inspect the appliance and to replace any part of the control system and any gas control which has been under water.

## MILLIVOLT WIRING SCHEMATIC

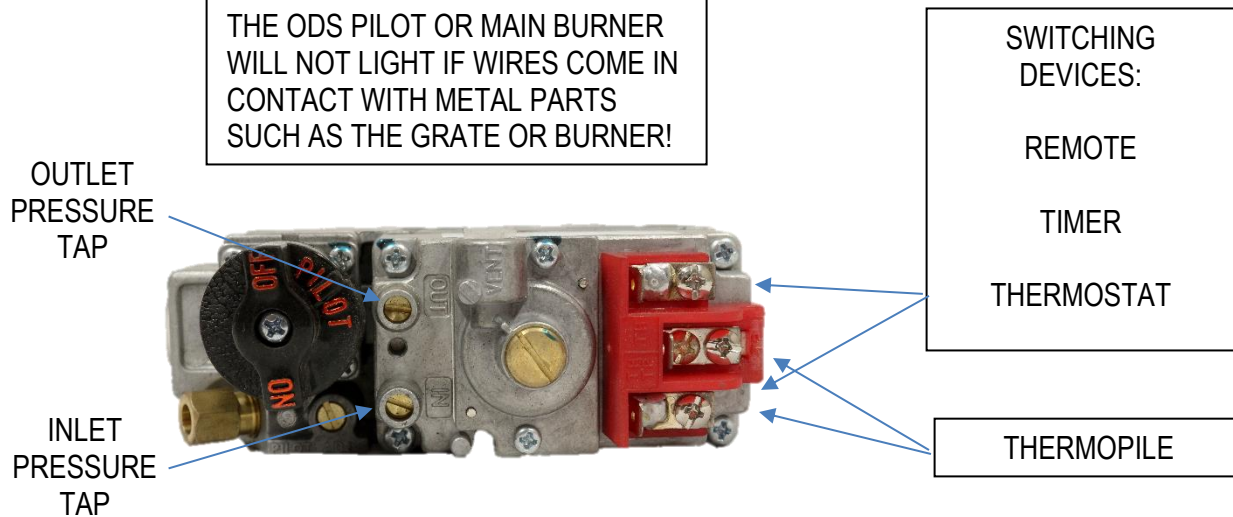

**CAUTION:** Label all wire prior to disconnection when servicing controls. Wiring errors can cause improper and dangerous operation. Verify proper operation after service.

\*\*\*If installing a remote control, thermostat, or timer, attach the leads from the optional item to the same terminals as the Wall Switch on the Millivolt Valve.



# COAL INSTALLATION

## COAL INSTALLATION

**FAILURE TO POSITION COALS PROPERLY MAY RESULT IN PROPERTY DAMAGE OR PERSONAL INJURY!**



FIG 1

BACK PIECE – FCVF4

MIDDLE PIECE – FCVF5

FRONT PIECE – FCVF6



FIG 2

**Step 1** – Identify each of the 6 coal pieces in the set by comparing them to the log picture above and below. (Fig 1,2,3 & 4)

**Step 2** – Identify the Back Piece (FCVF4) in the box, place the back piece on the grate with the finished area facing forward. (Fig 1 & 2)

**Step 3** – Install the Middle Piece (FCVF5) by placing the piece on the grate with the finished side facing forward. (Fig 1 & 2)

**Step 4** – Install the Front Piece (FCVF6) by placing the piece on the grate with the finished side facing forward. (Fig 1 & 2)

**Step 5** – Install the FCVF1 top piece by placing the flat end on the notch of the back piece and middle piece. (Fig 3 & 4)

**Step 6** – Install the FCVF1 top piece by placing the flat side of the piece on the notches on the front and middle pieces (Fig 3 & 4)

**Step 7** – Install the FCVF2 top piece by placing the flat side of the piece on the metal bracket on the right side of the set. (Fig 3 & 4)



FIG 3



FIG 4

**IMPORTANT: ASSURE THAT THE COALS ARE NOT POSITIONED ABOVE THE 2 SETS OF BURNER PORTS IN THE BACK OF THE SET.**

## SWITCH/REMOTE ATTACHMENT



Connect these terminals to the two terminals on your remote/switch.

## VOLCANIC CINDER PLACEMENT

The Volcanic Cinder is the large bag of black rock that is included in the log set. The purpose of it is to cover the fireplace floor surrounding the set. The Volcanic Cinder will also cover the metal Lighting Instruction tags and help keep them out of sight.



You may use the Volcanic Cinder to cover up the metal Lighting Instruction tags.

**VOLCANIC CINDER**

1. Once the burner system is in place, pour the Volcanic Cinder on the floor of the fireplace. **DO NOT POUR ANY VOLCANIC CINDER ON THE BURNERS OR AROUND THE PILOT.**

2. You may use the Volcanic Cinder to cover up the Lighting Tags that are attached to the set. **DO NOT REMOVE THE LIGHTING TAGS FROM THE BURNER SYSTEM. THIS WILL VOID THE MANUFACTURER'S WARRANTY.**

**DO NOT POUR VOLCANIC CINDER ON THE BURNER OR AROUND THE PILOT.**

**WARNING: GLASS DOORS MUST BE OPEN WHEN APPLIANCE IS IN OPERATION.**

# OPERATION

## FOR YOUR SAFETY READ BEFORE LIGHTING

- A. This appliance has a pilot which is lighted by a spark igniter system. When lighting the pilot, follow these instructions exactly.
- B. **BEFORE LIGHTING** smell all around the appliance area for gas. Be sure to smell next to the floor because some gas is heavier than air and will settle on the floor.

### WHAT TO DO IF YOU SMELL GAS:

- \*Do not try to light any appliance.
- \*Do not touch any electric switch; do not use any phone in your building.
- \* Immediately call your gas supplier from a neighbor's phone. Follow the gas supplier's instructions.
- \*If you cannot reach your gas supplier, call the fire department.

**WARNING:** If you do not follow these instructions exactly, a fire or explosion may result causing property damage, personal injury or loss of life.

C. Use only your hand to push in or turn the gas control knob. Never use tools. If the knob will not push in or turn by hand, do not try to repair it, call a qualified service technician. Force or attempt repair may result in a fire or explosion and may void your warranty.

D. Do not use this appliance if any part has been under water. Immediately call a qualified service technician to inspect the appliance and to replace any part of the control system and any gas control which has been under water.

## LIGHTING INSTRUCTIONS

**WARNING:** At no time should the "LIGHTING INSTRUCTION" tags be detached from the burner system. Removing the tags will void the manufacturer's warranty.

1. **STOP!** Read the safety information above on this label.
2. Turn off all electrical power in firebox before installing.
3. Depress the control knob and turn clockwise as far as it will go to reach the "OFF" position.
4. Wait five (5) minutes to clear out any gas. Then smell for gas, including near the floor. If you smell gas, STOP! Follow "B" in the safety information above on this label. If you do not smell gas, go to the next step.
5. Depress the control knob and turn counterclockwise to the "PILOT" position.

**Fig 10 GAS CONTROL**

Control Knob



6. Push in control knob **all the way** and hold in.
  - \* If the control knob is not held in all the way the pilot will not stay lit when the knob is released.
  - \* Do not turn the knob when pushing it in.
7. Light the pilot (mounted in front of the back burner) by pushing the spark igniter button several times. This will cause a spark at the pilot which will ignite the pilot gas. If the spark does not work, light the pilot with a match.
  - \* When lighting the pilot it may take several seconds for gas to reach the pilot.
8. Continue to hold the control knob in **all the way** for about 30 seconds after the pilot is lit.
9. Release the knob and it will pop back out. The pilot should remain lit. If it goes out, repeat steps 3 through 9.
  - \* If knob does not pop up when released, stop and immediately call your service technician or gas supplier.
  - \* If the pilot will not stay lit after several tries, turn the

7. Depress the control knob and turn counterclockwise to "ON". Turn flame height knob counterclockwise to select desired comfort level.

**IMPORTANT:** The gas control has an interlock device. After shutting off all gas flow, the pilot burner cannot be relit until the thermocouple has cooled, allowing the electromagnet to be released (approx. 60 sec.). The gas control knob is designed to be operated by hand. DO NOT use any tools during this operation. Damaged knobs may result in serious injury.

**NOTE:** A periodic visual check of the pilot flames (Figure 11) and main burner flames (Figure 12) should be made. The pilot flame should always be present when the appliance is in operation. See illustrations below.

**Fig 11**

**NATURAL GAS ODS PILOT**

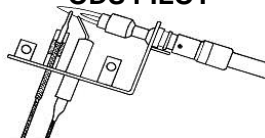

**LIQUID PROPANE ODS PILOT**

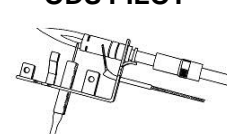

**WARNING: TAMPERING WITH THE ODS PILOT WILL VOID THE MANUFACTURER'S WARRANTY.**

**Fig 12**

**MAIN BURNER**



## TO TURN OFF GAS TO APPLIANCE

TEMPORARY SHUTDOWN PROCEDURE:	To turn off main burner only, depress the knob and turn it clockwise as far as it will go. Do not force.
COMPLETE SHUT-DOWN PROCEDURE:	Turn off all electrical power in firebox. Turn gas control knob clockwise to the "OFF" position.

### **Controlling Heat Output**

\* The heat output can be controlled by adjusting the vent free burner control knob.

\* Another way to regulate the heat output is to open the fireplace damper.

If you want:

- more heat radiated into the room – Keep the damper completely closed
- less heat radiated into the room – open the fireplace damper to varying degrees.

### **Important Safeguards**

1. To avoid personal injury, do not touch hot surfaces when the appliance is operating. Touch only the piezo ignitor and control knob.

Hot Surfaces

- Grate
- Burner
- Logs
- Surfaces above the opening of the fireplace

2. Although your gas logs are very realistic in appearance, it is not a real wood-burning fireplace and must not be used for burning any material.

\* To avoid irreparable damage to the appliance or personal injury, matches, paper, garbage, or any other material must not be placed or thrown on top of the logs or into the flames.

Close supervision is necessary when the appliance is being operated near children.

Avoid any drafts that alter burner patterns. Do not allow fans to blow directly into the fireplace. Ceiling fans may create drafts that alter burner flame patterns. Sooting and improper burning will occur.

### **Cleaning And Servicing**

Installation and repair should be done by a qualified service person. The appliance should be inspected before use and at least annually by a professional service person. More frequent cleaning may be required due to excessive lint from carpeting, bedding, and material, etc. It is imperative that control components, burners and circulating air passageways of the appliance be kept clean.

- If the flames show any unusual shapes or behavior, or the burners fail to ignite properly, then the burner holes may require cleaning.

**WARNING:** TURN OFF VENT FREE BURNER SYSTEM AND ALLOW TO COOL BEFORE CLEANING OR SERVICING.

#### **MONTHLY CLEANING**

- If removing logs, when reinstalling, refer to "Log Assembly Diagram" for correct log placement.
- Do not use cleaning fluids to clean logs or any part of the heater.
- Brush logs with a soft bristle brush or vacuum with brush attachment.
- Vacuum loose particles and dust from the front and rear burner ports, gas control, piezo cover, and grate.
- Inspect and clean ODS pilot for operation and accumulation of lint at air intake holes.
- Verify flame pattern and log placement for proper operation.
- Verify smooth and responsive ignition of main burner and rear burner. Refer to page for proper pictorial sketch of proper operation.

#### **ANNUAL CLEANING AND INSPECTION**

- Dealer or qualified inspector – follow the above steps for proper servicing and inspection.

# PARTS AND ASSEMBLY IDENTIFICATION – MANUAL AND MILLIVOLT VALVE

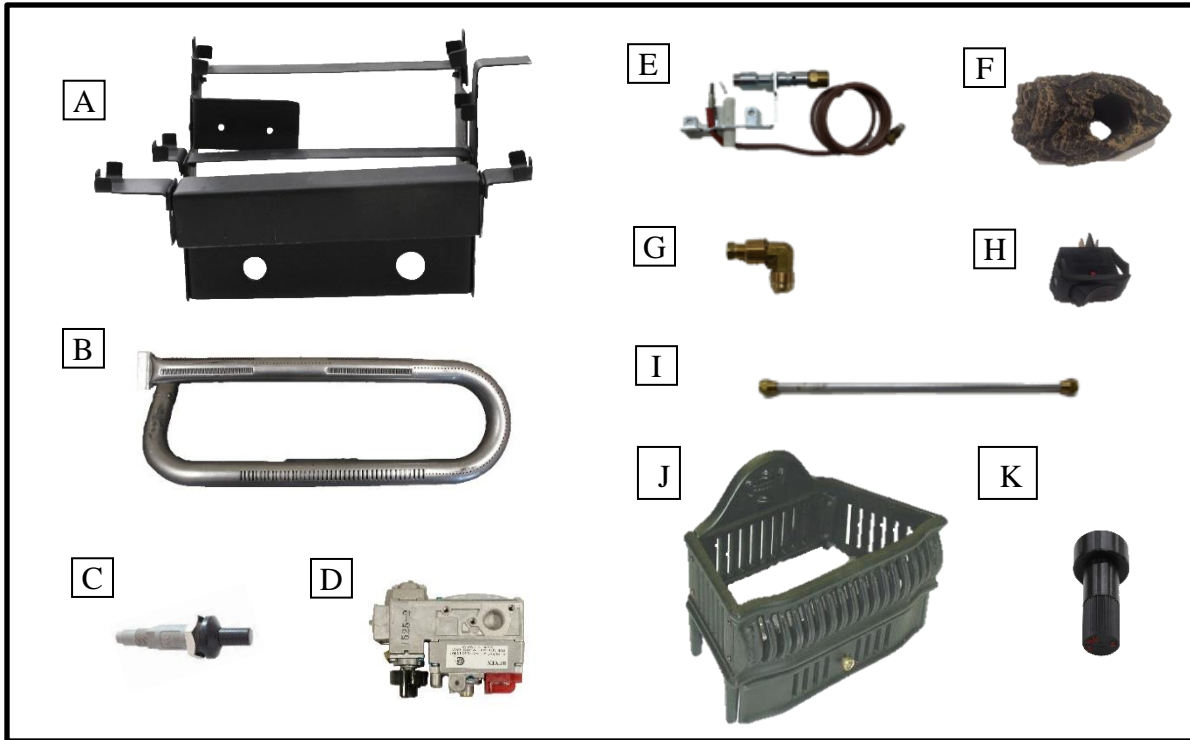

**WARNING:** Failure to position the parts in accordance with these diagrams or failure to use only parts specifically approved with this heater may result in property damage or personal injury.

## Millivolt Vent Free Burner Assembly

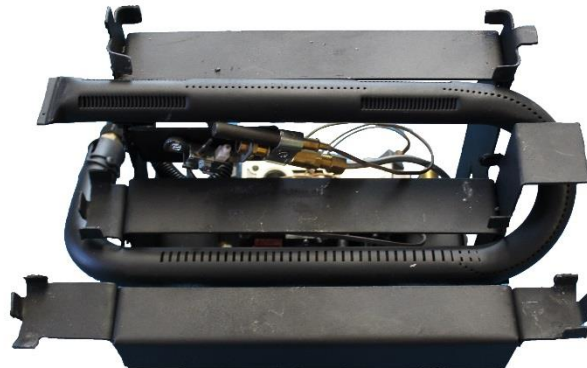

ITEM	DESCRIPTION	QTY	VFWR(18,24)(N,P)2C
A.	GRATE ASSEMBLY	1	GR-COAL
B.	COAL BURNER VENT FREE	1	HCB12
C.	PIEZO	1	PIEZO
D.	MILLIVOLT VALVE	1	DEX-MIL-VF-V
E.	ODS PILOT	1	OP-832-ODS
F.	BARK CHIP	1	BC1CL
G.	ORIFICE	1	49-6-6Z2
H.	ROCKER SWITCH	1	RS
I.	FLEX CONNECTOR	2	FCB-16
J.	GRATE	1	OG19
K.	3" EXTENSION KNOB	1	DMV-3EXT

# TRUBLE-SHOOTING

Hargrove Manufacturing test fires all Vent Free burner systems before shipment. Each test consists of lighting the pilot, checking for proper ignition, and leak testing at each connection. Even though all of these precautions are taken sometimes problems do arise. The following Trouble-Shooting chart lists several problems with their probable cause and remedy.

**WARNING:** TURN OFF AND LET COOL BEFORE SERVICING. ONLY A QUALIFIED SERVICE PERSON SHOULD SERVICE AND REPAIR.

<u>OBSERVE PROBLEM</u>	<u>POSSIBLE CAUSE</u>	<u>REMEDY</u>
A. When ignitor button is pressed there is no spark at the ODS.	<ol style="list-style-type: none"><li>1. Ignitor electrode positioned wrong.</li><li>2. Ignitor electrode is broken.</li><li>3. Ignitor electrode is not connected.</li><li>4. Ignitor cable is pinched.</li><li>5. Ignitor cable is wet.</li><li>6. Broken ignitor cable.</li><li>7. Bad piezo ignitor.</li></ol>	<ol style="list-style-type: none"><li>1. Replace ignitor.</li><li>2. Replace ignitor.</li><li>3. Reconnect ignitor cable.</li><li>4. Free ignitor cable if pinched by any metal or tubing.</li><li>5. Dry ignitor cable.</li><li>6. Replace ignitor cable.</li><li>7. Replace Piezo ignitor.</li></ol>
B. ODS pilot lights, but flame goes out when control knob is released.	<ol style="list-style-type: none"><li>1. Control knob not fully depressed.</li><li>2. Control knob not pressed in long enough.</li><li>3. Manual shutoff valve not fully open.</li><li>4. Thermocouple connection loose at valve.</li><li>5. Pilot flame not touching thermocouple, which allows thermocouple to cool, causing pilot flame to go out. This problem could be caused by one or both of the following:<ol style="list-style-type: none"><li>A) Log gas pressure.</li><li>B) Dirty or partially clogged ODS pilot.</li></ol></li><li>6. Thermocouple damage.</li><li>7. Control valve damage.</li></ol>	<ol style="list-style-type: none"><li>1. Press in control knob fully.</li><li>2. After ODS pilot lights, keep control knob pressed in 30 seconds.</li><li>3. Fully open manual shutoff valve.</li><li>4. Hand tighten ¼ turn more.</li><li>5. Contact local gas company.</li><li>6. Replace ODS pilot.</li><li>7. Replace control valve.</li></ol>
C. Appliance shuts off in use.	<ol style="list-style-type: none"><li>1. Not enough fresh air available for ODS pilot to operate.</li><li>2. Low gas pressure.</li><li>3. ODS pilot is partially clogged.</li><li>4. Unstable pilot flame due to drafts from ceiling fan, hot furnace register, open door etc...</li><li>5. If using damper, unstable pilot flame from downdrafts.</li></ol>	<ol style="list-style-type: none"><li>1. Open door to adjoining room for added ventilation or open window.</li><li>2. Contact local gas company.</li><li>3. Clean ODS pilot.</li><li>4. Locate and eliminate drafts.</li><li>5. Close damper.</li></ol>

# **TROUBLE-SHOOTING**

## **OBSERVE PROBLEM**

## **POSSIBLE CAUSE**

## **REMEDY**

D. When ignitor button is pressed there is spark at ODS pilot, but not ignition.

1. Gas supply turned off or manual shutoff valve closed.
2. Control knob not in PILOT position.
3. Control knob not pressed in while in PILOT position.
4. Air in gas line.
  
5. ODS pilot is clogged.

1. Turn on gas supply or open manual shutoff valve.
2. Turn control knob to PILOT position then depress knob.
3. Press in control knob while in PILOT position.
4. Continue holding down control knob. Repeat igniting operation until air is removed.
5. Clean ODS pilot.

E. Gas odor even when control knob is in the OFF position.

1. Gas leak.
2. Control valve defective.

1. Locate and correct all leaks.
2. Contact dealer to receive further instructions on correcting problem.

F. Slight odor during initial operation.

1. Smell coming from the paint curing on the logs and burner system.

1. Problem will stop after a few hours of operation. Run the heater with the damper open if you have one or open a window for the first few hours.

G. Main burner does not light after ODS pilot is lit.

1. Burner orifice is clogged.
2. Inlet gas pressure is too low.
3. Gas line obstruction. (pipe dope, Teflon tape, etc...)

1. Clean burner orifice and main burner.
2. Contact local gas company.
3. Locate and clear obstruction.

H. Delayed ignition of main burner.

1. Burner orifice is clogged.
2. Inlet gas pressure is too low.
3. Gas line obstruction. (pipe dope, Teflon tape, etc...)

1. Clean or replace burner orifice. Clean main burner.
2. Contact local gas company.
3. Locate and clear obstruction.

I. Main burner backfiring during combustion.

1. Burner orifice is clogged or damaged.
2. Inlet gas pressure is too low.
3. Gas line obstruction. (pipe dope, Teflon tape, etc...)

1. Clean or replace burner orifice. Clean main burner.
2. Contact local gas company.
3. Locate and clear obstruction.

J. Appliance produces unwanted odors.

1. Fresh paint fumes, cleaning agents, pet hair, or other particles are cycling thru the fireplace when it is operating.
2. Gas leak.

1. Ventilate room. Stop using odor causing products while heater is running.

2. Locate and correct all leaks.

K. Soot is depositing on logs, in fireplace, or in room.

1. Logs are not positioned properly and are obstructing the flame.
  
2. Main burner has accumulated dust or other small particles.

1. Logs must be repositioned so they do not come in contact with the flame.
2. Clean main burner.

# LIMITED WARRANTY

## Logs

Hargrove gas logs carry a limited lifetime warranty against any manufactured defect or breakage. A replacement will be available from the dealer at which the appliance was purchased. This warranty does not cover breakage caused by excessive handling once installed and fired.

## Burner & Grate

If the burner or grate fails due to deterioration within five (5) years of the verified purchase date, a free replacement will be made available from the dealer at which the appliance was purchased.

## Valves, Remote Controls, & Switching Devices

Hargrove warrants all valves, remote controls and switching devices against manufacturing defects which appear within two (2) years of the verified purchase date. Warranty does not cover products that have been damaged by misuse from overheating. Before any product is returned a Return Goods Authorization number (RGA) must be issued by Hargrove's Customer Service Department. All returns must be accompanied by an explanation of the problem and all necessary parts.

## All Other Parts

If any assembled part should fail to operate or be found defective which appear within two years of the verified purchase date, a replacement will be available from the dealer at which the appliance was purchased.

Buyer shall notify Hargrove Mfg Corp. of any defect covered by this warranty no later than thirty (30) days after defect is discovered. Failure to provide notice within thirty (30) days shall void the limited warranty.

## WHAT IS NOT COVERED

1. Removal and reinstallation costs.
2. Labor costs for replacement or repairs.
3. Transportation or shipping cost.
4. The cost of a service call to diagnose trouble.
5. Painted Surfaces.
6. Damage or defect caused by improper installation, accident, misuse, abuse, alteration, or authorized service technician.
7. Replacement of burner or combustion chamber resulting from improper storage of the appliance.

## LIMITATIONS AND EXCLUSIONS

1. No one has authority to add to or vary this limited warranty, or to create for Hargrove Manufacturing Corporation any other obligation or liability in connection with this appliance.
2. Any implied warranty applicable to this appliance is limited in duration to the same period of time as this written Warranty. Some states do not allow limitations on how long an implied warranty lasts, so the above limitations may not apply to you.
3. HARGROVE MANUFACTURING CORPORATION WILL NOT BE LIABLE FOR INCIDENTAL, CONSEQUENTIAL, SPECIAL OR CONTINGENT DAMAGES YOU MIGHT SUFFER AS A RESULT OF A CLAIM UNDER THIS WRITTEN WARRANTY OR ANY IMPLIED WARRANTY. Some states do not allow the exclusion or limitation of incidental or consequential damages, so the above limitations or exclusion may not apply to you.
4. This warranty applies only to the original purchaser and may not be transferred or assigned.
5. If you cannot verify the purchase date of the appliance, the warranty period will begin on the date of which the appliance was manufactured.
6. Replacement or repair parts are warranted for the remaining period of the original part warranty. Warranty parts must be obtained through authorized dealers of this product who will provide original factory replacement parts. Failure to use original factory replacement parts voids this warranty.
7. The maximum liability of Hargrove Mfg Corp. in connection with this limited warranty shall not in any case exceed the contract price paid for the product claimed to be defective or unsuitable.
8. Purchaser or user agrees to hold Hargrove Mfg Corp. harmless from any and all claims by the buyer as a result of injury or damage to an ultimate user or other person caused by the product sold herein by the seller to the buyer, whether the injury or damage results from the assembly, installation, operation, shipment, storage, or manufacture of this product. Hargrove Mfg Corp. makes no warranties, expressed or implied, other than those expressly stated herein.

## YOUR DUTIES

This appliance must be installed by a qualified installer, operated and maintained in accordance with all applicable codes and the instructions furnished with the appliance. You must provide a receipt verifying the purchase date of the appliance when making a warranty claim with the dealer from which the appliance was purchased.

This warranty gives you specific legal rights, and you may also have other rights, which vary from state to state.

**CONTACT INFO: Hargrove Manufacturing Corp.**  
**Tele: (800) 725-4166**