

Installation

Typical Installations

How To Plan Your Chimney Installation

Step 1.	Refer to the Typical PelletVent Pro Installations diagram, on the opposite page, to be familiar with some of the standard PelletVent Pro installations and the required component parts.
Step 2.	For a horizontal termination, you will need a Wall Thimble and a Horizontal Cap. The cap must be installed with a 6" clearance to the outside wall (refer to appliance manufacturer's installation instructions for other clearances).
Step 3.	For a vertical termination, you will need a Cathedral Ceiling Support Box or Flat Ceiling Support, Attic Insulation Shield (if passing through an attic), Flashing, Storm Collar, and Vertical Cap.
Step 4.	Determine the length of PelletVent Pro pipe required. For a vertical termination, measure the pitch of the roof and select the proper flashing. The required minimum height above the roof is 12".
Step 5.	Pellet stove inserts in masonry fireplaces will require a flex pipe to snake the vent past the smoke shelf. For transition from PelletVent Pro to an existing DuraPlus, DuraPlus HTC, or DuraTech Chimney, a Chimney Adapter is available.
Step 6.	For vertical rise of PelletVent Pro on the outside of the house, Wall Straps should be used at 4' intervals to provide proper support.
Step 7.	Important! Check to be sure that the appliance and the venting system are in compliance with all minimum clearance to combustible requirements.

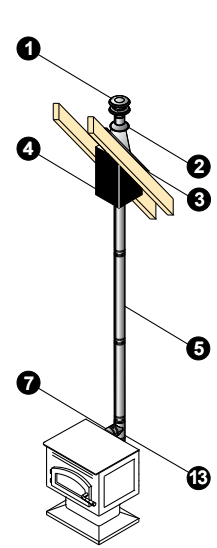

Cathedral Ceiling Stove Installation

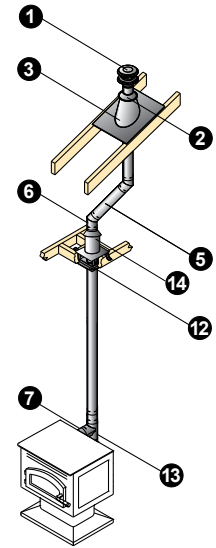

Attic Offset

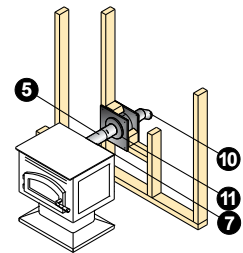

Through-the-Wall

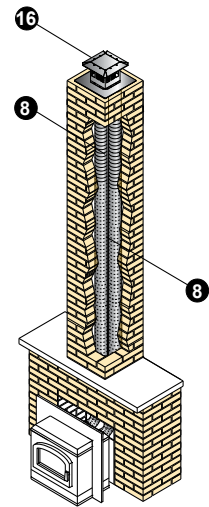

Pellet Insert

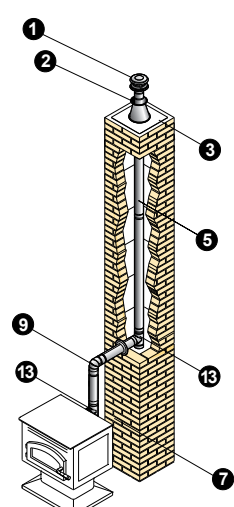

Masonry Chimney Relining

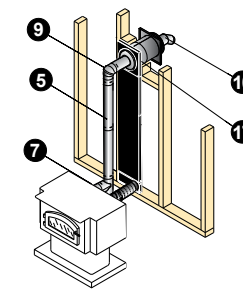

Through-the-Wall with Vertical Rise

PelletVent Pro

1	Vertical Cap
2	Storm Collar
3	Flashing
4	Cathedral Ceiling Support Box
5	Straight Length Pipe
6	45° Elbow
7	Appliance Adapter
8	Flex Length
9	90° Elbow
10	Horizontal Cap
11	Wall Thimble
12	Ceiling Support Firestop Spacer
13	Tee w/Clean-Out Tee Cap
14	Wall Strap
15	Attic Insulation Shield
16	Prairie Termination Cap
17	Combustion Air Adjustable Wall Channel

• Refer to our Typical Venting Installation drawings to select the appropriate component parts for your installation.

• The inner pipe diameter should match the outlet size of the appliance. For installations that require 4" vent and the appliance has a 3" outlet, use an Increaser Adapter 3" - 4".

• Check the appliance manufacturer's installation instructions to confirm which types of vent configurations are permitted (i.e. horizontal, vertical, chimney reline, etc.). Also, check for any venting restrictions such as maximum horizontal run, minimum and maximum vertical rise, maximum offset, etc.

• Be fire safe! Maintain the minimum clearances (air-space) between the vent pipe and nearby combustibles, as specified in the appliance manufacturer's installation instructions. Use proper support and bracing. Follow local building codes and have your venting system inspected.

Combustion Air Systems

DuraVent's patent-pending Combustion Air System (CAS) is the ultimate solution for supplying outdoor air as combustion air. Considered a direct vent for pellet appliances, the CAS wall thimble with air channel directs outside air into the pellet stove. It improves the efficiency of central heating systems by eliminating the use of conditioned air for combustion. The air is preheated as it travels down to the pellet stove. Excellent for bringing fresh air to basements. An elegant, simple design that installs with only one wall penetration.

How It Works

Outside air is drawn through the wall thimbles baffles, helping it pre-heat as it comes in contact with the hot inner exhaust pipe. The air continues down an air channel, through the aluminum flex and into the pellet stove, delivering fresh combustion air.

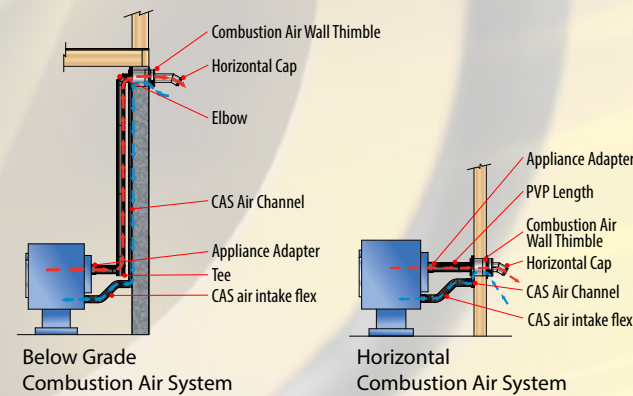
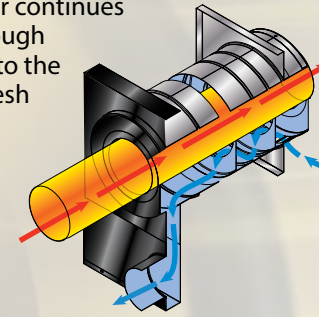

Contact

Professional Technical Help

DuraVent prides itself on providing the best customer service and technical support in the industry.

Our Customer Support Team is available to answer technical questions.

Monday – Friday
5:30am – 4pm PST | 8:30am – 7pm EST

Tel: 800-835-4429
Fax: 707-446-4740
customerservice@duravent.com



PelletVent® Pro
Biofuel venting system.
UL 641, ULC S609, and
ULC/ORD C441.

PelletVent® Pro

PelletVent® Pro

Applications

PelletVent Pro is a venting system designed for stoves and inserts that use wood pellets and oil fuel. It is also built to vent biofuel products such as corn, switch grass, cherry pits, soybeans, coffee husks, sunflower hulls, walnut shells and wheat, to name a few. (Rated for continuous use flue temperatures up to 570° F.)

Materials and Construction

Laser-welded, double-wall pipe with a .012" inner wall of 444 stainless steel and a .018" laser-welded galvalume outer wall. Painted black exterior available. Primary metal-to-metal connection seals joint. Encapsulated o-ring provides a secondary seal.

Clearances

1" clearance to combustibles in the USA and Canada for appliances using corn and other biofuels, wood pellets or oil.

Diameters

3" & 4"

Listings

c-UL-us Listed to UL 641 (MH8381 and MH14420).
ULC Listed to ULC S609, ULC/ORD C441 (CMH1439 and CMH1440).

PelletVent Pro











All PelletVent® Pro components that come into contact with flue gases are built with an inner wall of corrosion resistant superferritic metal. PelletVent Pro is engineered with features for a durable, safe and aesthetically pleasing venting system. PelletVent Pro is a patent-pending venting system for stoves and inserts that use wood pellets, corn and other biofuels, or oil, as fuel. As a result of DuraVent's cutting-edge manufacturing process and commitment to innovation, PelletVent Pro is uncompromised in attention to detail and performance. This perfect fit and finish is made possible with a laser-welded inner and outer wall. Select components are available in black.









PelletVent Pro is UL listed for 1" clearance to combustibles in the USA and in Canada. It's double-wall, air-insulated design offers superior performance. Seams are factory-sealed on all elbows, tees, and fittings. Since the introduction of pellet stoves in the 1980's, DuraVent is recognized as the industry leader in venting systems for pellet stoves. Today, approximately 3 of every 4 pellet stoves in the US and Canada are vented with a DuraVent pellet system.

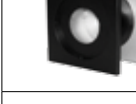





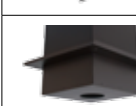



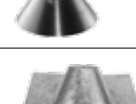

Product List

	Horizontal Kit For horizontal installations. Kit includes: Round Horizontal Cap, Wall Thimble, and Appliance Adapter. Pipe lengths not included. 4" Kit includes a 3"-4" Appliance Adapter/Incraser, painted black.
	Vertical Kit - Flat Ceiling For vertical installations. Kit includes: Vertical Cap, Storm Collar, Ceiling Support Firestop Spacer, Adjustable Flashing, and Appliance Adapter. Pipe lengths not included. 4" Kit includes a 3"-4" Appliance Adapter/Incraser, painted black. Support Clamp included.
	Vertical Kit - Cathedral Ceiling For vertical installations. Kit includes: Vertical Cap, Storm Collar, Cathedral Ceiling Support Box with trim and clamp, Adjustable Flashing, and Appliance Adapter. Pipe lengths not included. 4" Kit includes a 3"-4" Appliance Adapter/Incraser, painted black.
	Fresh Air Intake Kit Allows fresh air into an existing pellet stove installation. Kit includes: faceplate with screen, moisture barrier, aluminum flex, and two clamps.
	Straight Length Pipe 3" and 4" dia. stainless steel inner wall. Black or galvalume exterior. 6", 12", 24", 36", 60" lengths.
	Pipe Extension Use to add length to PelletVent Pro pipe. 12" pipe adds 3"-10" of length, 18" pipe adds 3"-16" of length, when used with rigid sections of pipe. Galvalume or painted black outer finish.
	BioFlex Pipe Use when relining masonry chimney for use with biofuel appliances. Made of super-ferritic stainless steel. Must be used with Male and Female Flex Adapters. Rigid pipe must be used when terminating system.
	Flex Pipe Use only inside a masonry chimney. 60" flex section. Allows for offsets. Female end swivels for easy alignment.
	Flex Trim Collar Use to connect PelletVent Pro rigid pipe to a masonry chimney with stainless steel flexible reliner. Female end swivels to allow ease of connection.

	Female & Male Flex Adapter Use to connect PelletVent Pro to BioFlex when relining a masonry chimney. Only approved for use with BioFlex.
	Appliance Adapter Attaches to appliance outlet allowing pipe to easily connect or disconnect. Seal adapter to appliance with high temperature sealant.
	Appliance Adapter / Incraser Attaches to appliance outlet to allow pipe to easily connect or disconnect. Connection of 4" vent to 3" appliance outlet. Horizontal or vertical.
	Quick Release Appliance Use to attach to appliance outlet allowing for easy pipe connection. Features an adjustable hose clamp and gasket to form a tight seal. The hose clamp can be loosened and tightened as needed to disconnect and connect the vent to the appliance.
	45° / 90° Elbow Use to offset pipe diagonally or horizontally. Swivels 360° at base. Angle not adjustable.
	Single Tee with Clean-Out Tee Cap Creates 90° offset with clean-out access. Removable twist-lock Clean-Out Tee Cap.
	Incraser Tee with Clean-Out Tee Cap Allows 3" branch to increase to 4" body and provides easy clean-out access. Removable twist-lock Clean-Out Tee Cap.
	Adapter Tee w/Clean-Out Tee Cap Use for a 90° offset. Attaches directly to appliance as an adapter. Removable twist-lock Clean-Out Tee Cap.
	Incraser Adapter Tee w/Clean-Out Tee Cap Use for a 90° offset. Attaches directly to appliance as an adapter. Converts a 3" appliance to a 4" system. Removable twist-lock Clean-Out Tee Cap.
	Double Tee w/Clean-Out Tee Cap Allows clean-out access for horizontal and vertical installations. Use for a 90° offset. Branch swivels for alignment. Removable twist-lock Clean-Out Tee Cap.

	Clean-Out Tee Cap Replacement Clean-Out Tee Cap for use with Tees.
	Wall Thimble Fits between standard wall studs. Interior trim painted black.
	Combustion Air Wall Thimble Kit A direct vent for bringing fresh outside air for combustion through air channel in wall thimble to appliance without cutting a second hole into the wall.
	Wall Thimble Air Intake Kit Brings fresh outside air for combustion through wall thimble without cutting a second hole into the wall.
	Ceiling Support Firestop Spacer Required where vent passes through a floor or flat ceiling. Centers pipe.
	Ceiling Support Firestop Spacer - 3" Clearance Required where vent passes through ceiling. Centers pipe to provide 3" clearance. Support Clamp included. Painted black.
	Wall Strap Use to support tee sections or as a wall strap. Provides 1" clearance.
	Adjustable Wall Support Use to support tee sections or as a wall strap. Adjusts to provide 1" to 3" clearance.
	Wall Strap Extension Use with Adjustable Wall Strap to increase extension from wall. Fits both 3" and 4" Adjustable Wall Strap.
	Cathedral Ceiling Support Box Use to support pipe with flat ceilings or sloped cathedral ceilings. Trim & clamp included.
	House Shield Use to protect exterior of structure from blower discharge in horizontal venting applications.

	Attic Insulation Shield Required for installations that pass through an attic to prevent insulation and debris from accumulating near the vent. Provides 1" clearance to combustibles.
	Roof Flashing Use to weather proof the penetration of chimney pipe through the roof.
	Storm Collar Maintains a weather tight resistant seal between the pipe and flashing.
	Vertical Cap Required when pipe terminates above roofline. Not for horizontal installations.
	Horizontal Cap Use for horizontal terminations only. Can be turned at the gore to direct exhaust output. Designed to create a venturi effect to force exhaust out.
	Square Horizontal Cap Use for horizontal terminations only. Cap features swivel collar to adjust exhaust direction. Cap features an optional swivel base.
	Ceiling Support / Wall Thimble Cover Use with reduction collar. Decorative cover for ceiling support boxes and wall thimbles.
	Reduction Collar Reduces the center hole diameter in the Ceiling Support / Wall Thimble Cover to fit 3" or 4" pipe.
	Incraser Allows transition from 3" to 4" pipe sections. Not a decreaser.
	Chimney Adapter Transitions between PelletVent Pro to existing chimney such as DuraTech, DuraPlus, or DuraPlus HTC.
	Prairie Termination Cap Use when installing a pellet insert into a multi-fuel pellet stove. This termination cap supplies both fresh air and vents exhaust.
	Fresh Air Inlet Incraser Use to increase an insert's 2" air inlet to connect to 3" aluminum flex.