

▶ VISUAL FLAME & CONSOLE ROOM HEATERS



SURROUND YOURSELF WITH COMFORT

- Total Comfort for a Fraction of the Cost of Electric Heat
- Heats Without Electricity
- Draft Diverter Installs in Horizontal or Vertical Position
- Open Design Allows Maximum Flow of Heat
- Matchless Pushbutton Piezo Ignition
- Automatic Blower Included on RH-50B, RH-50CB, RH-65B, and RH-65CB
- Optional Blower on RH-25, RH-35, RH-50C and RH-65C Heaters
- Optional Ceramic Logs for Visual Flame Heaters



EMPIRE CONSOLE VENTED ROOM HEATERS

25,000 Btu RH-25

35,000 Btu RH-35

Maximum air flow and heating are the strong points of the RH-25 and RH-35 Console Vented Room Heaters. Delivering warmth to your medium-size rooms, each unit is designed for style and efficiency. Add the optional internal blower for added circulation.

Quiet burners, a vent safety switch, “matchless” piezo ignition, and all the safety features you expect from Empire Comfort Systems® are standard equipment.

Plus, for total reliability, these room heaters include a hydraulic thermostat (needing no electricity to operate).

Ideal for medium to large rooms, each unit can be installed anywhere there is access to a vent. Housed in a durable, textured, powder-coated, beige cabinet, these room heaters look as good as they work for years.



▲ RH-35 (Vent Pipe Not Shown, Heater Must Be Vented)

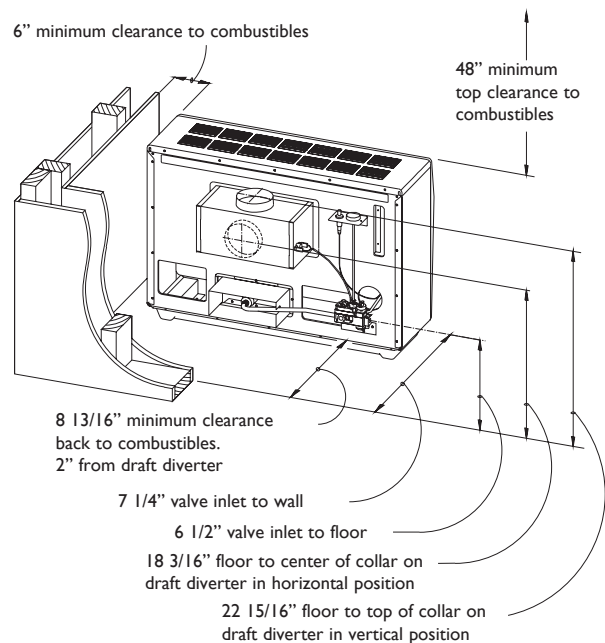

An EFFICIENT and SENSIBLE DESIGN

Empire Vented Room Heaters are crafted for visual appeal and maximum efficiency. Room heaters make ideal replacements for traditional wood-burning or coal-burning heaters. Just like a wood stove, they use room air for combustion. Vent pipes connect the heater to a chimney or flue to carry the by-products of combustion outside.

Empire Vented Room Heaters are designed for quiet operation. The curved combustion chamber design minimizes noise while the burner ignites the gas immediately as it enters the burner port for added efficiency.

SAFETY IS EVERYTHING at Empire

Empire Vented Room Heaters come standard with a vent safety switch that automatically shuts off the heater if it does not vent properly.

A simple piezo ignition system lights the pilot without matches.

EMPIRE VISUAL FLAME and CLOSED FRONT VENTED ROOM HEATERS

50,000 Btu RH-50B, RH-50C

65,000 Btu RH-65B, RH-65C

Heat large areas economically with Empire's Vented Room Heaters. With their efficient heat flow, the durable RH-50 and RH-65 offer ample warmth to make any room comfortable. The one-piece glass enclosure on the RH-50B and RH-65B allows you to see the flame as it heats, while the optional ceramic logs add visual interest. The closed front on the RH-50C and RH-65C easily fits in any decor.

Radiant and convection heat circulates the warmth while the blower (optional on the RH-50C and RH-65C) places warm air at floor level to give "barefoot" comfort throughout the winter season. The hydraulic thermostat needs no outside electricity assuring reliable, round-the-clock comfort. Each unit can be installed near any wall with access to a conventional vent.



▲ RH-50B Visual Flame Heater
(Vent Pipe Not Shown, Heater Must Be Vented)

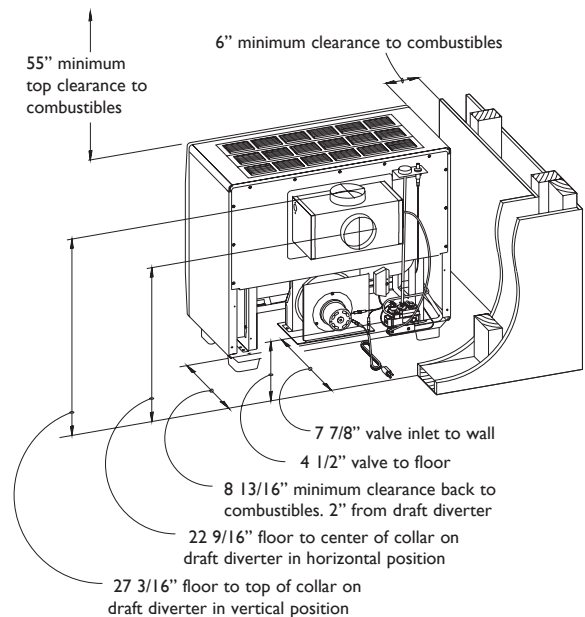

OPTIONAL Heater Accessories

Ceramic Log: Add the beauty and ambiance of a realistic wood fire with Empire's detailed log set for the RH-50B and RH-65B units.

Radiants: Eight ceramic radiants can be installed in the Visual Flame Room Heaters (RH-50B and RH-65B) for a radiant red-orange glow.

Blowers: Empire's automatic blower cycles on and off with the heater. Blowers are included on all RH-50B, RH-50CB, RH-65B and RH-65CB heaters and optional on RH-25, RH-35, RH-50C and RH-65C heaters.

WARM UP TO GAS, *Naturally*

Gas offers many heating advantages. It's clean burning and delivers comfortable heat at a fraction of the cost for electric heat. A gas heater eliminates the mess and inconvenience of kerosene or wood stoves. Gas keeps on heating your home, even when the electric power fails.

Model	RH-25	RH-35	RH-50B	RH-50C	RH-50CB	RH-65B	RH-65C	RH-65CB
Cabinet Color (powder coated)	Beige	Beige	Beige	Beige	Beige	Beige	Beige	Beige
Btu Input	25,000	35,000	50,000	50,000	50,000	65,000	65,000	65,000
Overall Dimensions								
Width	37"	37"	34"	34"	34"	34"	34"	34"
Depth	11 1/2"	11 1/2"	16"	16"	16"	20"	20"	20"
Depth Including Diverter	18 3/8"	18 3/8"	23 3/16"	23 3/16"	23 3/16"	27 11/16"	27 11/16"	27 11/16"
Height	26"	26"	29 9/16"	29 9/16"	29 9/16"	29 9/16"	29 9/16"	29 9/16"
Shipping Weight, lb. (One Carton)	84	88	124	124	124	142	142	142
Temperature Control								
Hydraulic Thermostat	Yes	Yes	Yes	Yes	Yes	Yes	Yes	Yes
Accessories (State on Order)								
Blower Kit	DRB-1	DRB-1	Included	FRB-3	Included	Included	FRB-3	Included
Output, Cu. Ft./Min.	75	75	100	100	100	100	100	100
Metal Floor Pad (36" x 21")	-	-	RH-425	RH-425	RH-425	RH-425	RH-425	RH-425
Metal Floor Pad (36" x 14")	DVP-1	DVP-1	-	-	-	-	-	-
Radiant Package	N/A	N/A	RAD-8	N/A	N/A	RAD-8	N/A	N/A
Ceramic Log	N/A	N/A	RHL-2	N/A	N/A	RHL-2	N/A	N/A
Minimum Clearances to Combustibles from:								
Top	48"	48"	55"	55"	55"	55"	55"	55"
Each Side	6"	6"	6"	6"	6"	6"	6"	6"
Opposite Side (for Accessibility)	18"	18"	18"	18"	18"	18"	18"	18"
Bottom of Unit to Wood Floor	0"	0"	0"	0"	0"	0"	0"	0"
Draft Diverter to Wall	2"	2"	2"	2"	2"	2"	2"	2"
Gas Inlet								
Type of Gas (State on Order)	Nat, or LP	Nat, or LP	Nat, or LP	Nat, or LP	Nat, or LP	Nat, or LP	Nat, or LP	Nat, or LP
Iron Pipe Size (N.P.T.)	1/2"	1/2"	1/2"	1/2"	1/2"	1/2"	1/2"	1/2"
Wall to Valve Inlet	7 1/4"	7 1/4"	7 7/8"	7 7/8"	7 7/8"	7 7/8"	7 7/8"	7 7/8"
Floor Covering to Valve Inlet	6 1/2"	6 1/2"	4 1/2"	4 1/2"	4 1/2"	4 1/2"	4 1/2"	4 1/2"
Center of Heater to Valve Inlet	Left 14 1/2"	Left 14 1/2"	Left 6 13/16	Left 6 13/16	Left 6 13/16	Left 6 13/16	Left 6 13/16	Left 6 13/16
Venting								
Size Flue Collar (Vertical or Horizontal)	4"	4"	5"	5"	5"	5"	5"	5"
Floor to Collar on Draft Diverter in Vertical Position	22 15/16"	22 15/16"	27 3/16"	27 3/16"	27 3/16"	27 3/16"	27 3/16"	27 3/16"
Floor to Center of Collar on Draft Diverter in Horizontal Position	18 3/16"	18 3/16"	22 9/16"	22 9/16"	22 9/16"	22 9/16"	22 9/16"	22 9/16"
Safety Control								
Pilot and Main Burners include Automatic Shut-off on All Vented Room Heaters.								
Warranty								
Combustion Chamber carries a 10-year limited warranty. All other parts carry a 1-year limited warranty.								

Note: Empire has a policy of constantly improving quality and performance of its appliances, therefore, materials and specifications are subject to change without notice.



Draft diverter may be rotated for horizontal or vertical installations.

FOR YOUR SAFETY

Due to high temperatures, the appliance should be located out of traffic and away from furniture and draperies.

Children and adults should be alerted to the hazard of high surface temperature and should be kept away to avoid burns or clothing ignition. Installation and repair should be done by a qualified service person.

This series is design certified in accordance with American National Standard/CSA Standard Z21.86 and CSA 2.32 by the Canadian Gas Association as Vented Room Heaters.

The installation must conform to local codes. In the absence of local codes, the installation must conform with American National Standard (National Fuel Gas Code) known as NFPA 54 and ANSI Z223.1 (latest edition) available from the American National Standards Institute, Inc., 11 West 42nd St., New York, N.Y. 10036, or from the National Fire Protection Association, Batterymarch Park, Quincy, Massachusetts 02269.

Read your Owner's Manual for complete installation and safety information

Note: A vent safety switch is standard on all models, automatically shutting the heater "off" in the event of a blocked flue or incorrect installation. (Example: Attaching a 90° elbow directly to the draft diverter is an incorrect installation.) The flue pipe diameter must be as large as the flue collar on the draft diverter and run as directly as possible to the chimney with a minimum of elbows.

The horizontal run of flue pipe must slope upward to the chimney at least 1/4" rise per foot of run, properly supported by metal straps, and enter the chimney so the end of the flue pipe is flush with the inner wall of the chimney. Any flue pipe passing through walls and roof must be "B" Type vent. The chimney must extend at least two feet above the roof and any object or building within 10 feet of the chimney. The flue pipe must NOT have any open tees or be connected to the chimney of an existing fireplace.



Empire Comfort Systems
918 Freeburg Ave.
Belleville, IL 62220-2623
E-mail: info@empirecomfort.com



©Empire Comfort Systems, Inc. EHS-00060 1/01/17