

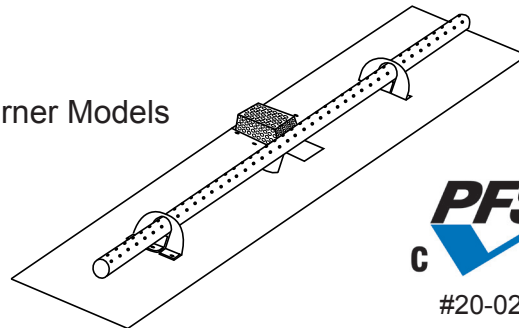

DO NOT DISCARD. THIS MANUAL HAS IMPORTANT OPERATING AND MAINTENANCE INSTRUCTIONS. LEAVE WITH THE HOMEOWNER.

MODEL:
SERIAL #:

T-Burner Models



MODELS

Models - Natural	Models - Propane	T- Burner	Input Rating
LOF-2408FTTPSI-N	LOF-2408FTTPSI-P	21" Burner	50,000 Btu's
LOF-3008FTTPSI-N	LOF-3008FTTPSI-P	27" Burner	50,000 Btu's
LOF-3608FTTPSI-N	LOF-3608FTTPSI-P	33" Burner	75,000 Btu's
LOF-4808FTTPSI-N	LOF-4808FTTPSI-P	45" Burner	100,000 Btu's
LOF-6008FTTPSI-N	LOF-6008FTTPSI-P	57" Burner	125,000 Btu's
LOF-7208FTTPSI-N	LOF-7208FTTPSI-P	69" Burner	150,000 Btu's

Outdoor Thermocouple Piloted Safety Ignition (TPSI) Fire Pits

Installation and Operating Instructions

IF YOU CANNOT READ OR UNDERSTAND THESE INSTALLATION INSTRUCTIONS DO NOT ATTEMPT TO INSTALL OR OPERATE THIS APPLIANCE

NOTE: All TPSI models come shipped from the factory as Natural gas or Propane (LP) gas. Only Natural gas models can be converted to Propane.

INSTALLATION PRECAUTION:



This fire pit requires a minimum 18-square inches (per side) of cross ventilation. Failure to provide proper ventilation can void the warranty.



Warning: For Outdoor Use Only



We recommend that our gas hearth products be installed and serviced by professionals who are certified in the U.S. by the National Fireplace Institute® (NFI) as NFI Gas Specialists.

 <p>DANGER</p>	<p align="center">CARBON MONOXIDE HAZARD</p> <p>This appliance can produce carbon monoxide which has no odor.</p> <p>Using it in an enclosed area can kill you.</p> <p>Never use this appliance in an enclosed space such as a camper, tent, car or home.</p>
	

DANGER

FIRE OR EXPLOSION HAZARD

If you smell gas:

1. Shut off gas to the appliance
2. Extinguish any open flame.
3. If odor continues, leave the area immediately.
4. After leaving the area, call your gas supplier or fire department.

WARNING

Do not store or use gasoline or other flammable vapors and liquids in the vicinity of this or other appliance.

An LP cylinder not connected for use shall not be stored in the vicinity of this or any other appliance.

WARNING

Do not leave unattended during use.
Do not use for cooking.
Follow all gas leak procedures in this manual prior to operation.

WARNING

Improper installation, adjustment, alteration, service or maintenance can cause injury or property damage, personal injury or loss of life
Read the owner's information manual provided with this appliance.
Installation and service must be performed by a qualified installer, service agency, or the gas supplier.

WARNING

If the information in this manual is not followed exactly, a fire or explosion may result causing property damage, personal injury, or **loss of life**.

FOR YOUR SAFETY

Do not store or use gasoline or other flammable vapors and liquids in the vicinity of this or other appliances.

 Fuels used in gas fired appliances, and the products of combustion such as fuels, contain chemicals known to cause cancer, birth defects and/or other reproductive harm.
This warning is issued pursuant to the California Health & Safety Code Sec. 25249.1



CALIFORNIA PROPOSITION 65



This product is designed to operate with one of the following fuel sources: Liquid Propane or Natural Gas. The fuel used to operate this product, and the products of combustion of such fuel, can expose you to chemicals including Benzene which is known to the State of California to cause cancer, birth defects and other reproductive harm and Carbon Monoxide which is known to the State of California to cause birth defects or other reproductive harm.

(For more information go to: www.p65Warnings.ca.gov.)

NOTE: An exterior lid/cover is not required but highly recommended when the fire pit is not in use. Even though fire pits are designed for outdoors they are not impervious to all weather conditions if not protected. See the accessory page for information and sizes.

TABLE OF CONTENTS

Specifications	4-5
Preparation for Non-Combustible Structure	6-7
Hard Piping to Fire Pit	6
Cross Ventilation Requirements	7
High Elevation	7
Installation into an Approved Enclosure	7
Gas Pipe Sizing Chart	8
Removing Parts from Carton	9
Installing Orifice & Control Panel	9
Media Requirements & Final Checks Before Operation	10
Typical Installation Drawings	10-11
Operation	12
Lighting Instructions	12
Replacement Parts	13
Replacement Parts List	14
Fire Pit Maintenance/Trouble Shooting	15
Optional Accessories	16



All media (i.e. lava rock, lava stones, lava boulders and fire glass) has the potential of thermal spalling. This is a process that may occur when media is wet and moisture gets trapped inside of the material due to rapid temperature differences. When this happens the media has the potential to crack or “pop” outside the fireplace.

WE HIGHLY RECOMMEND COVERING ALL FIRE FEATURES WHEN NOT IN USE

The use of a cover can lessen the impact of thermal spalling; however, heavy rains, high humidity and the presence of moisture may still cause the media to pop.

ALWAYS USE CAUTION WHEN USING THE FIRE FEATURE

Extra caution should be taken when lighting a fireplace when heavy rains, high humidity and moisture are present. Light the fireplace; leave the area allowing any moisture in the media to dissipate. We strongly recommend that during this drying out time that you monitor the fire feature from a distance. This drying out period should be no less than 30 minutes. Continue monitoring the flame from distance to ensure that all popping has ceased before fully enjoying the fire.



SPECIFICATIONS

MODELS N= Natural Gas P= Propane Gas	FLAT PAN DIMENSIONS A	BURNER LENGTH B	MAX OPENING DIMENSIONS	GROUND LEVEL	SIDE WALL	COMBUSTIBLE CEILING	COMBUSTIBLE FLOOR
LOF-2408FTTPSI-N LOF-2408FTTPSI-P	24" x 8" (609 x 203mm)	21" (533mm)	22" x 7" (558 x 152mm)	8" (203mm)	36" (914mm)	96" (2438mm)	18" (457mm)
LOF-3008FTTPSI-N LOF-3008FTTPSI-P	30" x 8" (762 x 203mm)	27" (686mm)	28" x 7" (711 x 152mm)	8" (203mm)	36" (914mm)	96" (2438mm)	18" (457mm)
LOF-3608FTTPSI-N LOF-3608FTTPSI-P	36" x 8" (914 x 203mm)	33" (838mm)	34" x 7" (889 x 152mm)	8" (203mm)	36" (914mm)	96" (2438mm)	18" (457mm)
LOF-4808FTTPSI-N LOF-4808FTTPSI-P	48" x 8" (1219 x 203mm)	45" (1143mm)	46" x 7" (1193 x 127mm)	8" (203mm)	36" (914mm)	96" (2438mm)	18" (457mm)
LOF-6008FTTPSI-N LOF-6008FTTPSI-P	60" x 8" (1524 x 203mm)	57" (1448mm)	58" x 7" (1498 x 152mm)	8" (203mm)	36" (914mm)	96" (2438mm)	18" (457mm)
LOF-7208FTTPSI-N LOF-7208FTTPSI-P	72" x 8" (1828 x 203mm)	69" (1752mm)	70" x 7" (1803 x 152mm)	8" (203mm)	36" (914mm)	120" (3048mm)	18" (457mm)

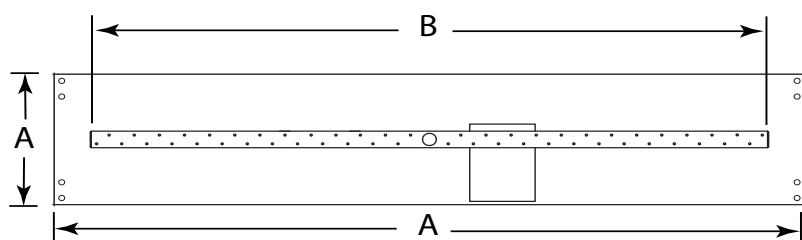

Fig. 1 T-style burner pan specifications.

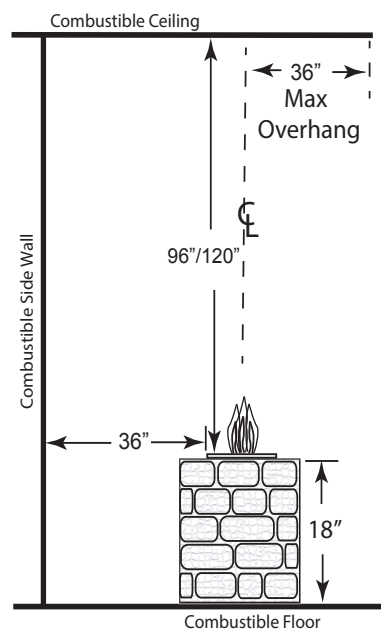

Fig. 2 Clearance to Combustibles for models. (Not to be used in an enclosed space)

Model: N= Natural Gas	NG Orifice	Model: P= Propane Gas	LP Orifice	Btu Ratings
LOF-2408FTTPSI-N	OAS-NG34	LOF-2408FTTPSI-P	OAS-LP47	50K (14.65kW)
LOF-3008FTTPSI-N	OAS-NG34	LOF-3008FTTPSI-P	OAS-LP47	50K (14.65kW)
LOF-3608FTTPSI-N	OAS-NG29	LOF-3608FTTPSI-P	OAS-LP41	75K (21.98kW)
LOF-4808FTTPSI-N	OAS-NG22	LOF-4808FTTPSI-P	OAS-LP35	100K (29.30kW)
LOF-6008FTTPSI-N	OAS-NG16	LOF-6008FTTPSI-P	OAS-LP31	125K(36.63kW)
LOF-7208FTTPSI-N	OAS-NG11	LOF-7208FTTPSI-P	OAS-LP29	150K (43.96kW)

Table 2 T-burner specifications. See LP conversions in accessory page.

Disclaimer: Btu listings are based on 7.0"WC for Natural Gas and 11.0"WC for Liquid Propane (LP) at the burner orifice. Flex line size and proper gas pipe sizing will also affect Btu's. As a result your Btu's may vary slightly from Table 2 specifications.

Pressure	NG	LP
Min. Inlet	3.5" WC (0.87 kPa)	8.0" WC (1.99kPa)
Max. Inlet	10.5" WC (2.61kPa)	13.0" WC (3.23 kPa)
Normal Inlet	7.0" WC (1.74 kPa)	11.0" WC (2.73 kPa)

Table 5 Gas pressures.



PREPARING A NON-COMBUSTIBLE STRUCTURE

Description: These fire pits are designed to be installed into a non-combustible enclosure. They are a “drop-in” style system to make installation quick and convenient. Media (not supplied) is required inside the burner pan for operation (See page 10).

WARNING: Proper clearances from combustible materials must be maintained from all sides, top and bottom of this appliance. Use the specifications listed on pages 4 and 5 for proper clearance to combustibles.

Firegear Outdoors fire pits are constructed and tested to follow the rigid ANSI standards for gas appliances and manufactured safely providing dependable and certified products. If these fire pits are not installed according to the installation manual (i.e. not providing ventilation, not providing proper drainage, installing fire pits below grade or modifying the existing products from a normal installation) Firegear Outdoors cannot be responsible if the product does not operate as designed.

Modifying the fire pit directly out of the carton will void the warranty and nullify the product listing it was certified for. Before you consider creating your own custom design with a certified product ensure you contact Firegear Outdoors to consult the installation before proceeding. If you move forward and modify a product without consulting, Firegear Outdoors cannot be responsible if the product does not operate as designed.

The fire pit can be installed on a flat, stable surface, away from any combustible materials. Install fire pit on any level, outdoor non-combustible, flat stable surface or a combustible floor according to the clearances specified in this manual. **NOTE:** Do not place fire pit directly on grass, dirt, or rocks this may prevent proper ventilation. **Ensure proper water drainage is also incorporated into the fire pit enclosure.**

HARD PIPING TO FIRE PIT WITHOUT GAS PROXIMITY

NOTE: Refer to the NFPA54 (National Fuel Gas Code) for proper pipe sizing. See gas line sizing chart on page 8 as a reference.

1. Turn **OFF** gas supply system. **NOTE:** All gas connections (except for brass to brass) require the following. Clean pipe threads using either a wire brush or steel wool. Apply pipe sealant to the fittings before making any connection.

BE CAREFUL! Ensure all gas connections are snug, but do not over tighten!

2. Extend the gas supply system using minimum of ¾” black iron pipe or an approved flexible gas line from existing house supply. This can be accomplished by teeing off or tapping into a gas line connection. Install necessary pipe for the distance required and then install a manual shut-off valve at the exterior house wall. If pipe is to pass through a foundation or house wall, make sure to re-seal the area around the pipe with weather sealant.

3. The primary gas shut-off (not supplied) will require a ¾” male flared fitting to enable connection of the stainless steel flex gas line supplied with the fire pit (see Fig. 12 page 11).

IMPORTANT

Installation of Natural or LP gas should be done by a qualified installer, service agency or gas supplier. This appliance must be isolated from the gas supply piping system by closing its manual shutoff valve during any pressure testing of the gas supply piping system at test pressures equal to or less than ½” psig (3.5kPa)



ALL PAN OR FLAT DISCS MUST BE REMOVABLE FOR SERVICE Pans or Discs CANNOT be installed in a manner to prevent them from being removed for service. Top coping material or top cap of fire pit MUST NOT overlap onto the pan or disc surface without easily being removed. Pan lip of disc edge must be unobstructed so it can be lifted out of the fire pit for servicing. We highly recommend the use of a flex frame kit for all installations.



PREPARING A NON-COMBUSTIBLE STRUCTURE

VENTILATION FOR NON-COMBUSTIBLE ENCLOSURE

Fire pits are subjected to many outdoor elements such as rain, snow, wind, heat or cold. **A minimum of 18 square inches (two opposite sides) of cross ventilation is required to keep the components in good working order.** Use Fig. 4 as guide to assist to incorporate proper ventilation.

HIGH ELEVATION INSTALLATION

This appliance is listed for elevations from 0- 4500 feet in Canada and the U.S. If elevation exceeds 4500 feet it may be necessary to decrease the input rating by changing the existing burner orifice to a smaller size. Input should be reduced 4% for each 1000 feet beyond the 4500 feet above sea level. Check with your local gas utility for assistance in determining the proper orifice in your location. In some cases the heating value may already be reduced and downsizing the orifice may not be necessary.

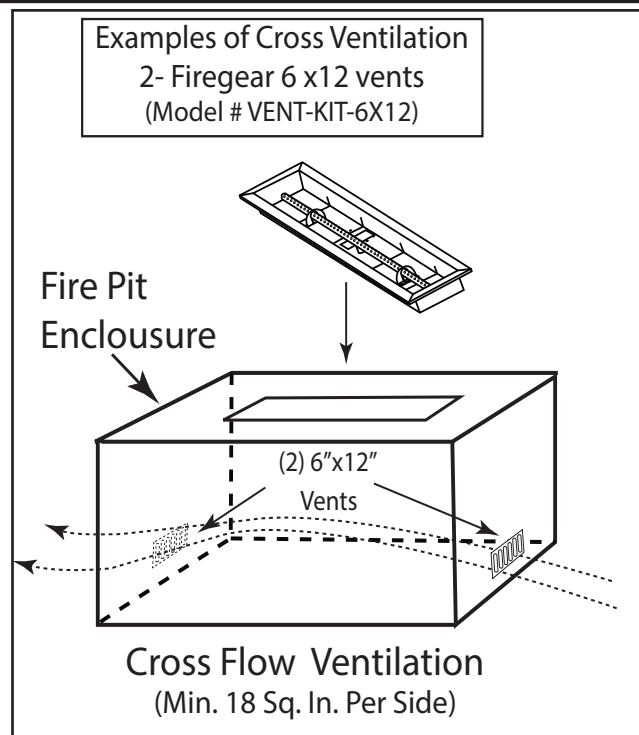

Fig. 4 Cross ventilation example

INSTALLATION OF FIRE PIT INTO AN APPROVED ENCLOSURE

REQUIREMENTS

1. Only non-combustible materials should come in direct contact with any part of the fire pit. Underneath area should be non-combustible or a flat level combustible surface according to the clearances specified in this manual.
2. Refer to the NFPA54 (National Fuel Gas Code) for proper pipe sizing. Determine the size of the fire pit you are preparing to install (Refer to page 8).
3. You must provide a rectangular opening cutout to place the fire pit into the non-combustible enclosure. Refer to Table 1, dimension A.
4. Follow the local code requirements for the gas type being used. This fire pit should be installed in accordance with local codes and ordinances or in the absence of local codes, with the latest National Fuel Gas Code, ANSI Z223.1 NFPA54 or CSA B149.1, Natural and Propane Installation Code in Canada.
5. Fire pits create high temperatures, it is very important to have any combustibles at a safe distance.
6. **CAUTION: A minimum of 18 square inches of cross ventilation (opposite side) is required to keep the enclosure dry. See Fig. 4.**
7. These products are **designed for outdoor use only**. Not approved for any indoor use.
8. This fire pit is designed to have Firegear Outdoors lava rock or glass media completely covering the burner tube, so that the burner is not visible. Do not cover more than 1" above the top of burner. Use lava rock a minimum of 1" diameter as a base to fill the burner pan. **DO NOT USE STONE OR RIVER ROCK.**
9. Gas lines and fittings must be installed in to the non-combustible structure. All gas connections must be leak tested before installation of the fire pit. Soapy water leak detection is required before regular use of the fire pit.
10. Do not use media that will absorb moisture over time and will not release this moisture quickly. Moisture can boil in this material and can rapidly break apart and cause damage or personal injury. See Caution on bottom of page 3.
11. Never leave any combustible material on top of the fire pit. This could cause unsafe operation of this system and damage to the component that will not be covered under our warranty.
13. Ensure proper water drainage is also incorporated into the fire pit enclosure.



GAS PIPE SIZING CHART

NATURAL GAS : PIPE SIZING CHART

Length of Pipe in Feet	1/2"	3/4"	1"	1 - 1/4"	1 - 1/2"	2"	2 - 2 1/2"	3"	4"
10	108	230	387	793	1237	2259	3640	6434	-
20	75	160	280	569	877	1610	2613	5236	9521
30	61	129	224	471	719	1335	2165	4107	7859
40	52	110	196	401	635	1143	1867	3258	6795
50	46	98	177	364	560	1041	1680	2936	6142
60	42	89	159	336	513	957	1559	2684	5647
70	38	82	149	317	476	896	1447	2492	5250
80	36	76	140	239	443	840	1353	2315	4900
90	33	71	133	275	420	793	1288	2203	4667
100	32	68	126	266	411	775	1246	2128	4518
125	28	60	117	243	369	700	1143	1904	4065
150	25	54	105	215	327	625	1008	1689	3645
175	23	50	93	196	303	583	993	1554	3370
200	22	47	84	182	280	541	877	1437	3160
300	17	37	70	145	224	439	686	1139	2539

- Natural Gas (NG) flow is given in thousands of BTU/hr. = 1 cubic foot of NG gas - 1000 BTU
- Nominal pressure at the burner for Natural Gas is 3.5" of water column. (Typical machine supply 5"-7")
- Pipe length must include additional length for all fittings. Add approximately 5 feet of pipe per fitting.
- Natural Gas Example: A machine with a burner that requires 440,000 BTU would need a 1 -1/4" pipe for a 20" long run.

LIQUID PROPANE : PIPE SIZING CHART

Length of Pipe in Feet	1/2"	3/4"	1"	1 - 1/4"	1 - 1/2"	2"	2 - 2 1/2"	3"	4"
10	275	567	1071	2205	3307	6221	10140	17990	35710
20	189	393	732	1496	2299	4331	7046	12510	25520
30	152	315	590	1212	1858	3465	5695	10110	20620
40	129	267	504	1039	1559	2992	4778	8481	17300
50	114	237	448	913	1417	2646	4343	7708	15730
60	103	217	409	834	1275	2394	3908	6936	14150
70	89	185	346	724	1086	2047	3329	5908	12050
80	78	162	307	630	976	1811	2991	5309	10830
90	69	146	275	567	866	1606	2654	4711	9613
100	63	132	252	511	787	1496	2412	4281	8736
125	54	112	209	439	665	1282	2083	3618	7382
150	48	100	185	390	590	1138	1808	3210	6549
175	43	90	168	353	534	1030	1637	2905	5927
200	40	83	155	325	491	947	1505	2671	5450
300	37	77	144	303	458	887	1404	2492	5084

- Liquid Propane (LP) Gas flow is given in thousands of BTU/hr. = 1 cubic foot of LP gas - 2500 BTU.
- This chart refers to low pressure LP, after regulation, Standard nominal pressure at the burner for Liquid Propane Gas is 11" of water column.
- Pipe length must include additional length for all fittings. Add approximately 5 feet of pipe per fitting.
- LP Example: A machine with a burner that requires 440,000 BTU would need a 1" pipe for a 20' long run.

NOTE: The sizing charts above list the specific pipe sizes required for the amount of BTU's for a new gas line installations. If you are using an existing gas line you must take into consideration the existing gas line capacities to ensure you will have proper pressure. **This chart is for reference only, we recommend you consult with a Licensed Plumber/Gas Fitter or NFPA54 (National Fuel Gas Code - current edition) for more details.**

Table 6 Gas pipe sizing.



REMOVING PARTS FROM CARTON

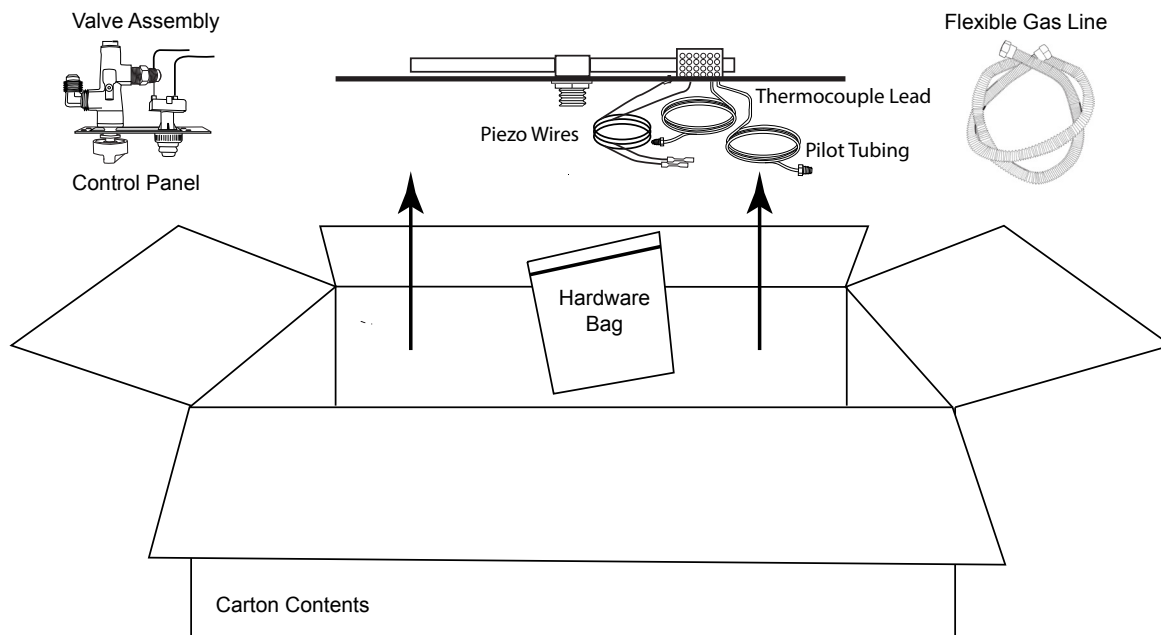

Fig. 5 Removing contents from carton.

This fire pit comes partially assembled from the factory. The pilot tubing and thermocouple leads are 48" in total length, therefore, when mounting the Gas Valve/Piezo mounting plate, ensure the mounting plate is close enough to make all connections.

Open carton and remove contents. Inspect for any damage or missing parts.

The hardware bag include mounting plate screws, orifice, Piezo wires and flex connector to complete the installation.

Carefully install the fire pit into the prepared enclosure, connect the gas line and wire according to the figure drawings in this manual.

INSTALLING BURNER ORIFICE (OAS)

Before the fire pit is installed:

Locate the burner nipple underneath the burner pan. Ensure the nipple on the spur burner has gas rated Teflon tape wrapped around the threads (See Fig. 6).

Install the OAS (orifice air shutter) to the nipple of the burning spur in a clock wise manner. Secure into position.

CONTROL PANEL MOUNTING PLATE

The control panel mounting plate is pre-assembled at the factory with the gas valve and Piezo ignitor. On the back of this manual is a template for use to cut an opening for the mounting plate. Once you have determined the location of control panel mounting plate install the gas connections and Piezo wires as shown in Fig. 7 and secure all connections.

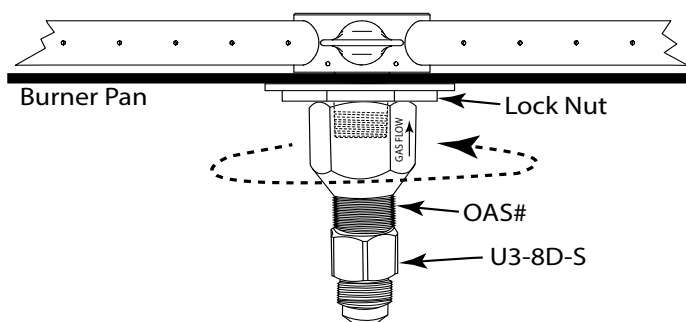

Fig. 6 Installing OAS assembly to spur burner.

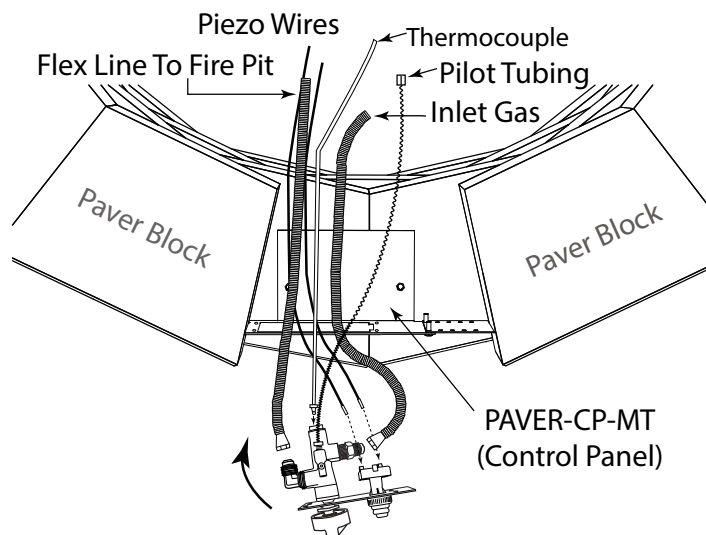

Fig. 7 Installing control panel into PAVER-CP-MT mounting plate.



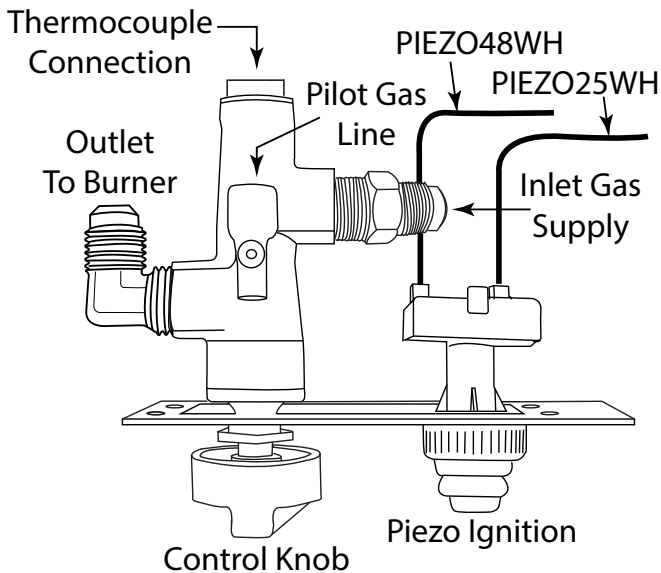

Fig. 8 TPSI control panel mounting plate.

PILOT ASSEMBLY

It is important to understand that this is a “standing pilot” system. When placing media around the pilot area ensure the top of the screen hood/cover is open to exhaust the gasses and enable the pilot to operate properly. See Fig. 10.

INSTALLATION OF LAVA ROCK/MEDIA INTO FIRE PIT

Install lava rock/media into the burner pan. Ensure the lava rock is a 1 to 2-inch diameter for proper operation. **Note:** Do not pour Lava Rock directly from bag. It should be placed naturally and NOT packed in tight. Loose fitting is important to ensure robust flames. Be sure rocks are free of any excessive dust. This prevents the burner pan weep holes from being plugged and holding water.

IMPORTANT: Do not place media directly on top or under the screen cover. The screen must be free of any debris to ensure proper lighting of burner and good flame sense (See Fig. 11).

Cover the burner completely with media but do not make the depth greater than 1-inch overtop of the burner port-holes.

Do NOT cover the top of the screen hood with any rock or glass. It must be free of any debris to operate properly.

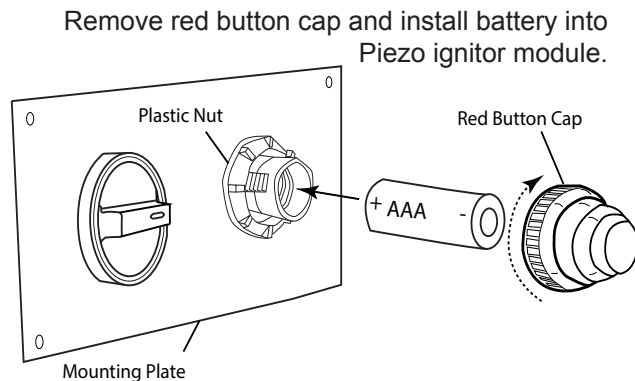

Fig. 9 Installing battery into Piezo.

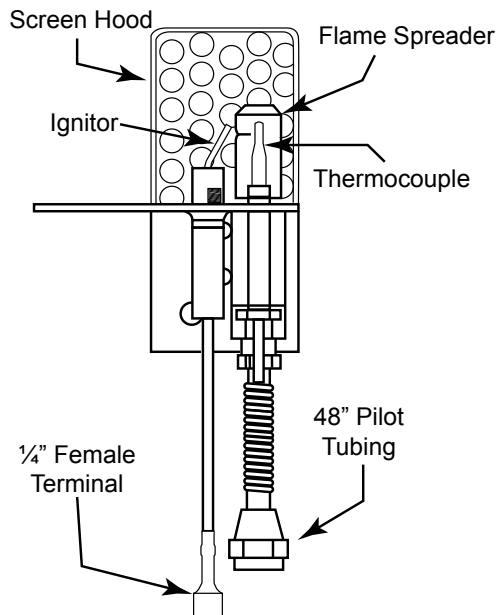

Fig. 10 Show TPSI pilot assembly identification.

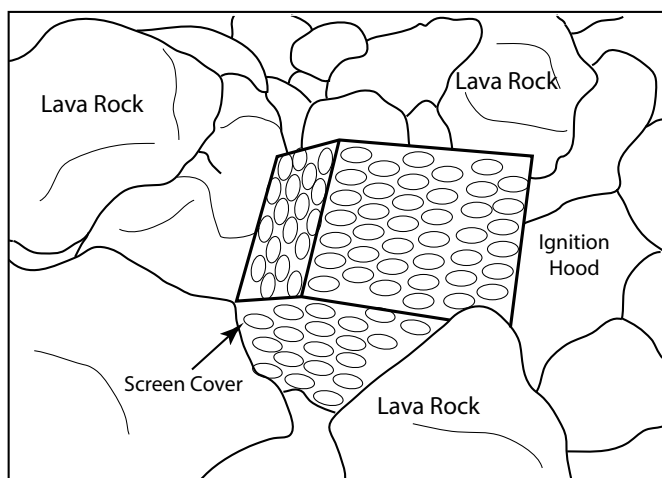
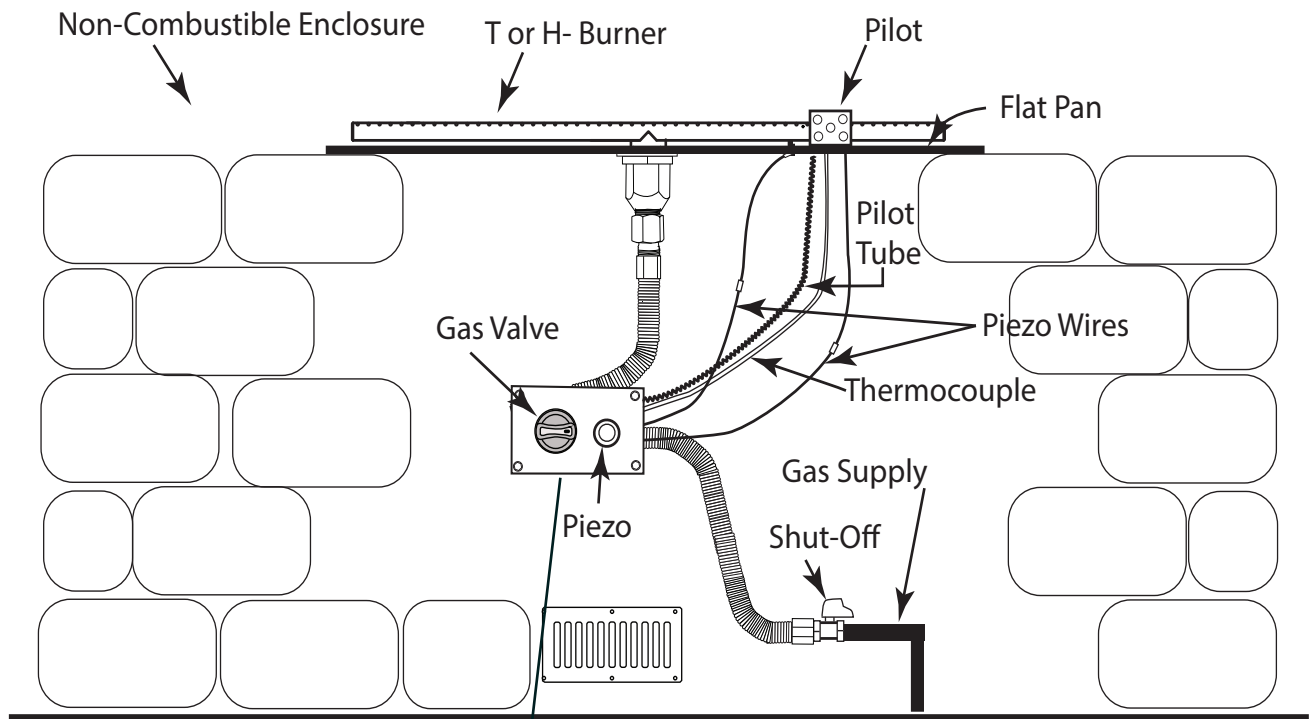
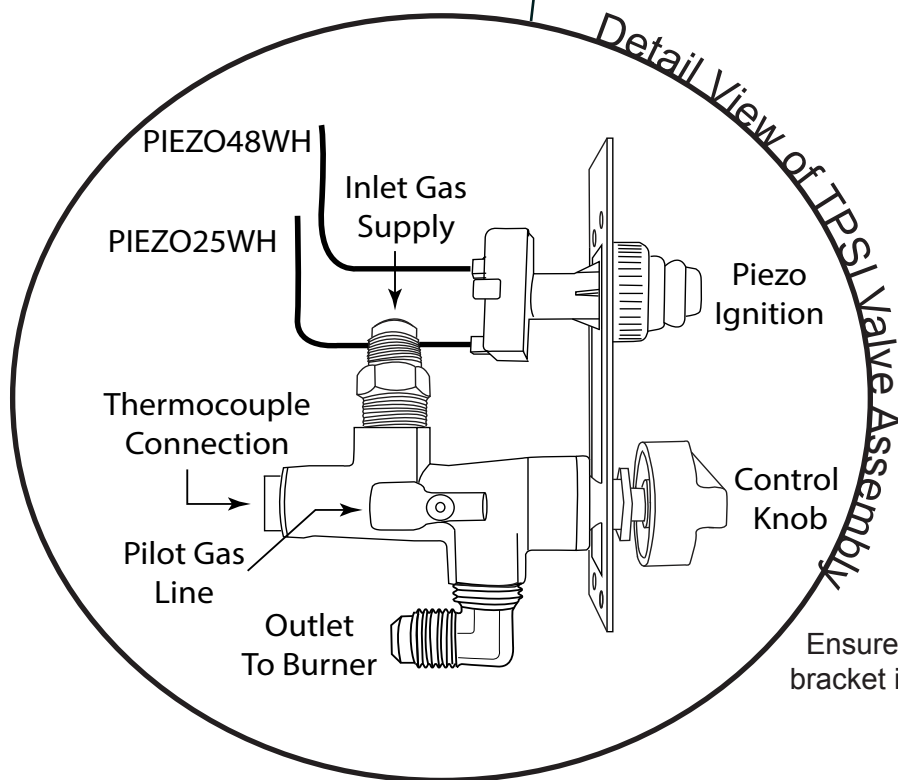

Fig. 11 Keep screen cover exposed





Gas valve and flexible gas lines are supplied; E-Stop shut-off is not supplied, but available in accessories page. Flex lines with flared fittings do not require Teflon tape or pipe compound. Ensure not to “kink” the flex lines to allow better gas flow of gas. The illustration above is only a guide for the gas connection. Local codes may require different methods to connect the gas supply. **Note: See optional mounting method of TPSI face plate on back of this manual.**



Ensure you determine how to mount valve bracket into place before completing fire pit.

Fig. 12 Typical installation.



OPERATION

CAUTION: Children and adults should be alerted to the hazards on high surface temperatures and should stay away to avoid burns or clothing ignition. Young children should be carefully supervised when they are in the area of the appliance.

WARNING: Do not use this appliance if any part has been under water. Immediately call a qualified service technician to inspect the appliance and to replace any part of control system and any gas control, which has been under water.

SAFETY WARNINGS

1. Never leave the fire pit unattended during operation.
2. Clothing or other flammable materials should not be placed on or near the appliance.
3. Any guard or other protective device removed for servicing the appliance must be replaced prior to operating the appliance.
4. Installation and repair should be done by a qualified service person. The appliance should be inspected before use and at least annually by a qualified service person. More frequent cleaning may be required as necessary. It is imperative the control compartment, burners and circulating air passageways of the appliance be kept clean.
5. Inspect the fuel supply connection before each use of the appliance.
6. Temporary storage of this appliance indoors is permissible only if it has been disconnected from its fuel supply (Natural or L.P. gas line).

WARNING

1. This appliance is hot when operated and can cause severe burns if contacted.
2. Do not burn any solid fuels in this appliance.

READ ALL LIGHTING INSTRUCTIONS BEFORE ATTEMPTING TO LIGHT FIRE PIT

CAUTION: ENSURE YOU HAVE LEAK TESTED THE FIRE PIT BEFORE OPERATING.

WARNING: Do not stand over fire pit during ignition or operation due to high surface temperatures.

LIGHTING INSTRUCTIONS

TURNING ON FIRE PIT

1. Depress and hold the red Piezo button and ensure sparking is occurring inside the pilot hood. An audible sparking sound can be heard.
2. While holding the Piezo button, slightly depress the control knob inward and rotate counter clockwise to the PILOT position. Depress and hold control knob inward for at least 30 to 60 seconds; to light the PILOT.
3. Once the pilot lights, release the Piezo button and turn control knob counter clockwise to the ON position. If pilot does not stay lit, release the control knob, turn the control knob clockwise to turn OFF and wait 5 minutes before trying again. Turn gas supply OFF to check ignitor spacing and Piezo battery if no sparking occurs.
4. Repeat steps 1-4 to try again.

TURNING OFF FIRE PIT

1. Slightly depress the control knob inward and rotate the knob clockwise to OFF position. Fire pit will turn OFF.
2. After cooling off install cover (if applicable).

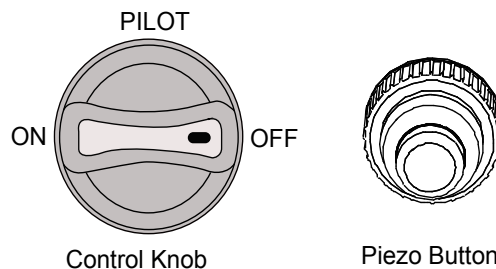
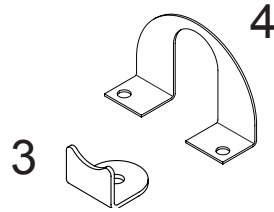
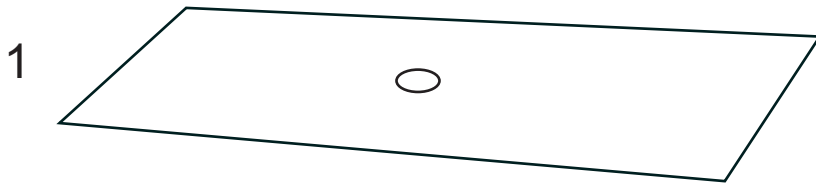

Fig. 13 Control panel with gas valve knob and Piezo.



AWS REPLACEMENT PARTS



7

Drawings Not to Scale

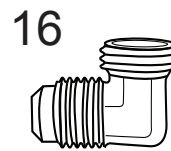
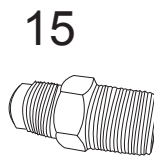
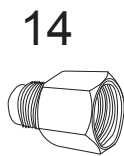
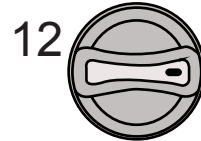
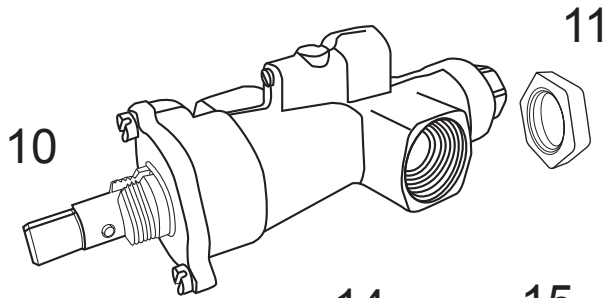
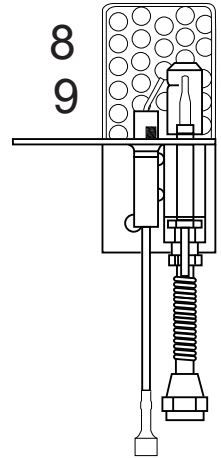
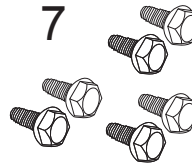
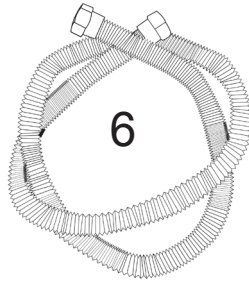
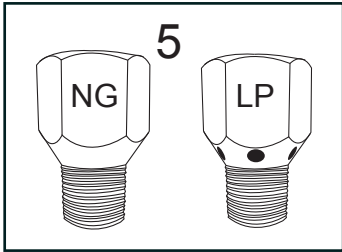

13

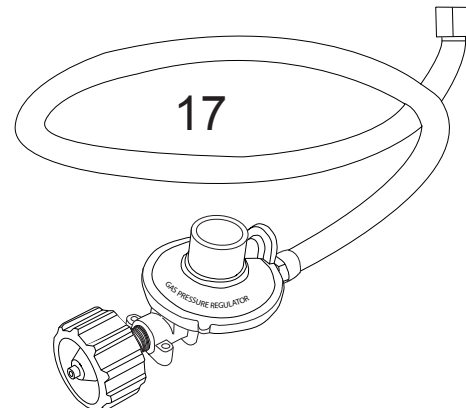
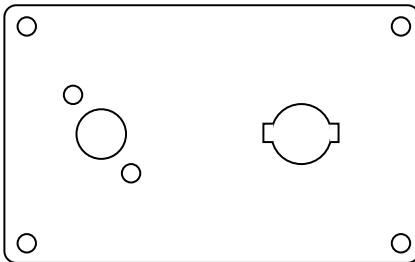

REPLACEMENT PARTS

Item	Description	Qty.	Part Number
1	24" x 8" LT-Flat Burner Pan (Used with 21" T-burner)	1	78047
1	30" x 8" LT-Flat Burner Pan (Used with 27" T-burner)	1	78057
1	36" x 8" LT-Flat Burner Pan (Used with 33" T-burner)	1	78049
1	48" x 8" LT-Flat Burner Pan (Used with 45" T-burner)	1	78050
1	60" x 8" LT-Flat Burner Pan (Used with 57" T-burner)	1	78051
1	72" x 8" LT-Flat Burner Pan (Used with 69" T-burner)	1	78052
2	21" T- Burner Only (used with 24" x 6" T-burner pan)	1	10615
2	27" T- Burner Only (used with 30" x 6" T-burner pan)	1	10600
2	33" T- Burner Only (used with 36" x 6" T-burner pan)	1	10601
2	45" T-Burner Only (used with 48" x 6" T-burner pan)	1	10602
2	57" T-Burner Only (used with 60" x 6" T-burner pan)	1	10603
2	69" T-Burner Only (used with 72" x 6" T-burner pan)	1	10612
3	Burner Tube Support Bracket	1	78019
4	Burner Tube Hook Bracket	1	78020
5	OAS# (Orifice air shutter) for Natural Gas/ LP Gas Fire Pits Refer to page 4 (H-burners) and page 5 (T-burners) for specific orifice sizes/ model numbers.	1	Refer to pages 4 & 5
6	½" Flex Gas Line (46-inch Length)	1	T-200-9898-46
7	Stainless Steel Thread Cutting Screws #10-24x ½"	8	ST3-113-1028
8	Complete Natural Gas Pilot Assembly with 48" leads	1	PSE-NA495
9	Complete Propane Gas Pilot Assembly with 48" leads	1	PSE-LP495
10	Copreci High Capacity Gas Valve	1	68001599
11	Lock Nut, M15 x 1 for TPSI Gas Valve	1	08032504
12	Gas Valve Control Knob for TPSI Valve	1	CN-ALHC
13	TPSI Face Plate	1	78188
14	½" OD Flare to 3/8" MIP Fitting	1	U1-8C-S
15	½" NPT Female to ½" Male Flare Fitting	1	U3-8D-S
16	½" Flare to ½" MIP 90° elbow	1	49-88
17	LP Regulator with 32" Hose - NOT FOR USE WITH NATURAL GAS	1	FG-32LPHRK
18	Manual Spark Ignitor Module (not shown)	1	3042-RB
19	Spark Ignitor for 3042-RB (not shown)	1	3042-RB -IGNITOR
20	Plastic Nut for 3042-RB (not shown)	1	3042-RB-NUT
21	25" Piezo Extension wire - See page 16 (not shown)	1	PIEZO25WH
22	48" Piezo Extension wire - See page 16 (not shown)	1	PIEZO48WH
23	Ground tab for Piezo ignition (not shown)	1	GROUNDTAB



FIRE PIT MAINTENANCE

1. The fire pit should be inspected and cleaned before initial use at least annually by a qualified field service person.
2. Any component that is found faulty must be replaced with an approved component.
3. Any tampering or modifying with the fire pit is dangerous and voids all warranties.
4. During winter months in cold climates and various seasons operation the fire pit may be affected by weather conditions. It is recommended to use a cover/lid overtop of your fire pit to protect it from humid/rainy weather conditions when not in use. Heavy rains/downpours could affect the fire pit operation if not covered; if this occurs ensure you allow the fire pit time to dry out before attempting to operate. **NOTE:** If a combustible type cover is used over the fire pit when not in use be sure to remove it before operation to prevent a severe safety hazard.
5. Carbon (soot) may build up on the surface of logs (if installed) during heavy use. Sooting may also occur periodically on the screen of the ignitor hood. To clean, brush off with a dry bristle brush or cloth. Keep soot away from clothing or furniture.
6. Over time stainless steel parts can discolor when heated, usually a golden or brown hue. This discoloration is normal and does not affect the performance of the appliance.

TROUBLE SHOOTING

<u>Symptom</u>	<u>Remedy</u>
Fire pit won't light	<ol style="list-style-type: none">1. Bleed gas line.2. Ensure all gas supply lines are turned ON.3. Ensure there is not too much media overtop of burner; it can inhibit gas from flowing.
Low Flame	<ol style="list-style-type: none">1. Ensure the base media is at least 1-inch in diameter and top media is no more than 1-inch over top of burner.2. Ensure all shut-off valves and valve is fully open.3. Check for spider webs inside burner orifice.
Water in my fire pit	<ol style="list-style-type: none">1. Excess dust/sand material from media may be blocking the weep holes to relieve water.2. Remove all media and unplug weep holes. Clean or install new media free of dust and dirt.3. Ensure fire pit enclosure has proper drainage for water and proper ventilation to dry out.4. Recommend to purchase a cover/lid to keep excessive water out of the fire pit.
Whistling Noises	<ol style="list-style-type: none">1. Check media to ensure it is not too tightly packed around the burner tube.2. Ensure a non-whistling flex connector is being used.
Fire Pit Shuts Off After A Short Period of Operation	<ol style="list-style-type: none">1. Windy days can potentially blow pilot flame out. Gusts of 25-30mph or higher can cause pilot intermittent outage.2. Too much media around the pilot can cause thermocouple to overheat.3. Operating the fire pit after heavy rains can potentially cause pilot outage. Let the fire pit completely dry before using.



OPTIONAL ACCESSORIES

The following accessories are available from your local Firegear Outdoors dealer/distributor.
Each accessory comes with a separate installation manual. Read each instruction thoroughly before installing.

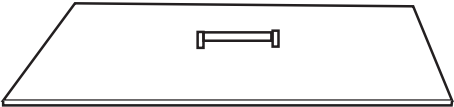
 <p><u>Lids for H-Burner Fire Pits</u></p> <p>Models: LID-LOF2406, LID-LOF3006, LID-LOF3606, LID-LOF4806, LID-LOF6006, LID-LOF7206</p>	<p style="text-align: center;"><u>Media</u></p> <p><i>Lava Stones</i> 1" to 2" size (50lbs.) Models: FG-LS50 (Bag)</p> <p><i>Lava Rock</i> 1" to 2" size Models: FG-LAVA-40 (Bag) FG-LAVA-10 (Bag)</p> <p>See catalog for various colors.</p>	<p style="text-align: center;"><u>Glass Windshields</u></p> <p>See catalog for a windshield to fit your application.</p> <p style="text-align: center;"><u>FLEXFRAME</u></p> <p>Universal brackets to support fire pit when using paver blocks or other non-combustible enclosures.</p> <p>Model: FLEXFRAME-SS (2 piece) Model: FLEXFRAME-SS3 (3 piece)</p>
<p style="text-align: center;"><u>Paver Control Panels</u></p> <p>PAVER-CP-TPSI TPSI systems</p> <p style="text-align: center;"><u>Vent Kits</u></p> <p>Provide 18 sq. in of ventilation per side of enclosure)</p> <p>Model: VENT-KIT-6X12SS Model: PAVER-VENT-4-LNTS Model: PAVER-VENT-6-LNTS</p>	<p style="text-align: center;"><u>E-STOP</u></p> <p>Mechanical gas timer valve with emergency shut-off.</p> <p>Model: ESTOP1-0H 1hr. timer Model: ESTOP2-5H 2.5hr. timer</p>	<p style="text-align: center;"><u>Shut-Off Valves</u></p> <p>Model: 01-387 3/8" OD Flare x 1/2" FIP Model: 01-487 1/2" OD Flare x 1/2" FIP Model: 01-266 3/8" OD Flare x 3/8" OD Flare Model: 01-288 1/2" OD Flare x 1/2" OD Flare</p>
<p style="text-align: center;"><u>Natural Gas to LP Conversion Kits</u></p> <p>Models: TPSI-LPK29 - 150K Btu models TPSI-LPK31 - 125,000 Btu models TPSI-LPK35 - 100,000 Btu models TPSI-LPK41 - 75,000 Btu models TPSI-LPK47 - 50,000 Btu models - Kits include main burner orifice and PSE-SUB163 pilot orifice</p>		

NOTE: See the Firegear Outdoors catalogue for other accessories also available.

FOR TECHNICAL SERVICE, CALL: (800) 966-8126

Firegear Outdoors
17322 Gothard St.
Huntington Beach, CA 92647
Web Site: www.firegearoutdoors.com

Manual changes often occur, ensure to check the Firegear Outdoor website for any recent updates and warranty information.



FIREGEAR LIMITED WARRANTY - 2022

Firegear Outdoors hereby warrants to the end user that products will be free from material and workmanship defects that prevent safe and correct operation of the product. The warranty commences from date of sale to the end user for the following period:

CONSUMER RESIDENTIAL APPLICATIONS – MANUFACTURED AFTER 12/02/2019

- BURNER SYSTEMS, BURNERS, COMPONENTS AND ACCESSORIES
- LIFETIME WARRANTY ON CONSTRUCTION AND MANUFACTURER DEFECTS
- LIFETIME WARRANTY - STAINLESS STEEL BURNERS AND PANS
- LIFETIME WARRANTY - BRASS BURNERS
- FIVE (5) YEAR WARRANTY - GAS VALVE, SPARK IGNITER, PILOT ASSEMBLIES
- FIVE (5) YEAR WARRANTY - AWS ELECTRONIC IGNITION SYSTEMS (24VAC, 30 VDC)
- FIVE (5) YEAR WARRANTY - TFS/TMSI ELECTRONIC COMPONENTS
- FIVE (5) YEAR WARRANTY – MT COMPONENTS (KEY VALVE)
- FIVE (5) YEAR WARRANTY - REFRACTORY GAS LOG SETS
- FIVE (5) YEAR WARRANTY - READY TO FINISH/ANF FIRE PIT ENCLOSURES
- FIVE (5) YEAR WARRANTY – SKYTECH MANUFACTURED OPTIONAL CONTROLS

OUTDOOR FIREPLACE – KALEA BAY

- LIFETIME WARRANTY - CONSTRUCTION AND MANUFACTURER DEFECTS
- LIFETIME WARRANTY - STAINLESS STEEL COMPONENTS
- FIVE (5) YEAR WARRANTY - GAS VALVE, PILOT ASSEMBLY, POWER SUPPLY, CONTROLS
- FIVE (5) YEAR WARRANTY – SKYTECH MANUFACTURED OPTIONAL CONTROLS

SANCTUARY SERIES – GFRC FIRE FEATURES

- THREE (3) YEAR WARRANTY - GFRC STRUCTURE
- REFER TO THE APPROPRIATE BURNER SYSTEM FOR WARRANTY

WARRANTY COVERS MANUFACTURING DEFECTS OR STRUCTURAL FAILURE. SMALL STRESS CRACKS AND SURFACE CRAZING ARE A NATURAL OCCURRENCE IN GFRC PRODUCTS AND NOT COVERED BY WARRANTY.

READY TO FINISH/ANF ENCLOSURES

- FRAME – LIFETIME WARRANTY ON CONSTRUCTION AND MANUFACTURER DEFECTS

ACCESSORIES

- LIFETIME WARRANTY - CONSTRUCTION AND MANUFACTURER DEFECTS
- LIFETIME WARRANTY - STAINLESS STEEL COMPONENTS (LIDS, STAINLESS STEEL COVERS)
- ONE (1) YEAR WARRANTY – ESTOP1-OH, ESTOP2-5H WINDSHIELDS, HOSES AND REGULATORS



COMMERCIAL APPLICATIONS – MANUFACTURED AFTER 12/02/2019

BURNER SYSTEMS, BURNERS, COMPONENTS AND ACCESSORIES

- TWO (2) YEAR WARRANTY ON CONSTRUCTION AND MANUFACTURER DEFECTS
- TWO (2) YEAR WARRANTY - STAINLESS STEEL BURNERS AND PANS
- TWO (2) YEAR WARRANTY - BRASS BURNERS
- TWO (2) YEAR WARRANTY - GAS VALVE, SPARK IGNITER, PILOT ASSEMBLIES
- TWO (2) YEAR WARRANTY - AWS ELECTRONIC IGNITION SYSTEMS (24VAC, 30 VDC)
- TWO (2) YEAR WARRANTY – MT COMPONENTS (KEY VALVE)
- TWO (2) YEAR WARRANTY - REFRACTORY GAS LOG SETS
- FIVE (5) YEAR WARRANTY - READY TO FINISH/ANF FIRE PIT ENCLOSURES
- TWO (2) YEAR WARRANTY – SKYTECH MANUFACTURED OPTIONAL CONTROLS

OUTDOOR FIREPLACE – KALEA BAY

- LIFETIME WARRANTY - CONSTRUCTION AND MANUFACTURER DEFECTS
- LIFETIME WARRANTY - STAINLESS STEEL COMPONENTS
- TWO (2) YEAR WARRANTY - GAS VALVE, PILOT ASSEMBLY, POWER SUPPLY, CONTROLS
- TWO (2) YEAR WARRANTY – SKYTECH MANUFACTURED OPTIONAL CONTROLS

SANCTUARY SERIES – GFRC FIRE FEATURES

- THREE (3) YEAR WARRANTY - GFRC STRUCTURE
- REFER TO THE APPROPRIATE BURNER SYSTEM FOR WARRANTY
WARRANTY COVERS MANUFACTURING DEFECTS OR STRUCTURAL FAILURE. SMALL STRESS CRACKS AND SURFACE CRAZING ARE A NATURAL OCCURRENCE IN GFRC PRODUCTS AND NOT COVERED BY WARRANTY.

READY TO FINISH/ANF ENCLOSURES

- FRAME – LIFETIME WARRANTY ON CONSTRUCTION AND MANUFACTURER DEFECTS

ACCESSORIES

- LIFETIME WARRANTY - CONSTRUCTION AND MANUFACTURER DEFECTS
- LIFETIME WARRANTY - STAINLESS STEEL COMPONENTS (LIDS, STAINLESS STEEL COVERS)
- ONE (1) YEAR WARRANTY – ESTOP1-OH, ESTOP2-5H WINDSHIELDS, HOSES AND REGULATORS



The end-user must provide a bill of sale, canceled check, or payment record to verify the purchase date and to establish the warranty period. This Limited Warranty shall be valid and limited to the original purchaser only.

WARNING: Any modification to the product will void the warranty.

This Limited Warranty shall be limited to the repair and/or replacement of parts that have been proven to be defective under normal use and service. All warranty claims must be made by the OEM/Distributor/Dealer account on behalf of the end-user. You may contact Technical Support at 800-966-8126.

Our Technical Service Department must confirm all approved defects. If a defect is confirmed and we approve the claim, we will replace such parts without charge. This warranty gives you specific legal rights, and you may also have other rights, which vary from state to state.

The manufacturer may request defective products returned with an RMA (Return Merchandise Authorization) issued by Firegear Outdoors for specific products, which is considered to be the nature of the defect and or warranty claim. Product to be returned should; be packed so as not to incur damages during transportation. Firegear is not responsible for damages on returned items. RMA is valid for thirty (30) days from the date issued. The RMA must be clearly marked on the outside of the package.

Please check with your local building code department or governing agency for proper approvals before purchasing. Firegear Outdoors is not responsible for any violation of local codes.

Travel, diagnostic cost, service labor to repair the defect on warranty parts to and from the factory will be the responsibility of the owner. We will not be responsible for labor charges and/or damage incurred in installation, repair, and replacement. Firegear is not responsible for Issues related to gas or electrical installation.

The Limited Warranty is voided if not assembled, installed, and operated as intended. This Limited Warranty does not cover any defects due to accident, abuse, misuse, alteration, misapplication, vandalism, improper installation or improper maintenance or service, removal from the original location, or re-installation into another location, or failure to perform normal and routine maintenance.

Damage due to severe weather conditions such as hail, hurricanes, earthquakes, tornadoes, discoloration due to overheating, exposure to chemicals (including chlorine and salt), either directly or in the atmosphere, or very high humidity, is not covered by this Limited Warranty. Coastal, humid and/or salt environments are subject to manufacturer review. All out-of-box claims must be made within 30 days of purchase and must be made prior to installation. Any product installed damaged will be considered damaged during installation and not covered under warranty.

There are no other express warranties except as set forth herein. For consumer applications, any applicable implied warranties of merchantability and fitness are limited in duration to the period of coverage of this Limited Warranty. Some states do not allow limitation on how long an implied warranty lasts, so this limitation may not apply to you.

For Commercial Applications, the liability of Firegear Outdoors is limited to the express terms of this warranty. We expressly disclaim any and all implied warranties, including any warranties of fitness for a particular purpose or merchantability.



We are not liable for any special, indirect or consequential damages. Our maximum liability is limited to the purchase price of the purchased units. Some states do not allow the exclusion or limitation of incidental or consequential damages, so this limitation or exclusion may not apply to you.

We do not authorize any person or company to assume for it any other obligation or liability in connection with the sale, installation, use, removal, return, or replacement of its equipment, and or such representation are binding.

Firegear Outdoors
17322 Gothard St.
Huntington Beach, CA 92647
www.firegearoutdoors.com
Phone: 800-966-8126
Email: order@firegearoutdoors.com



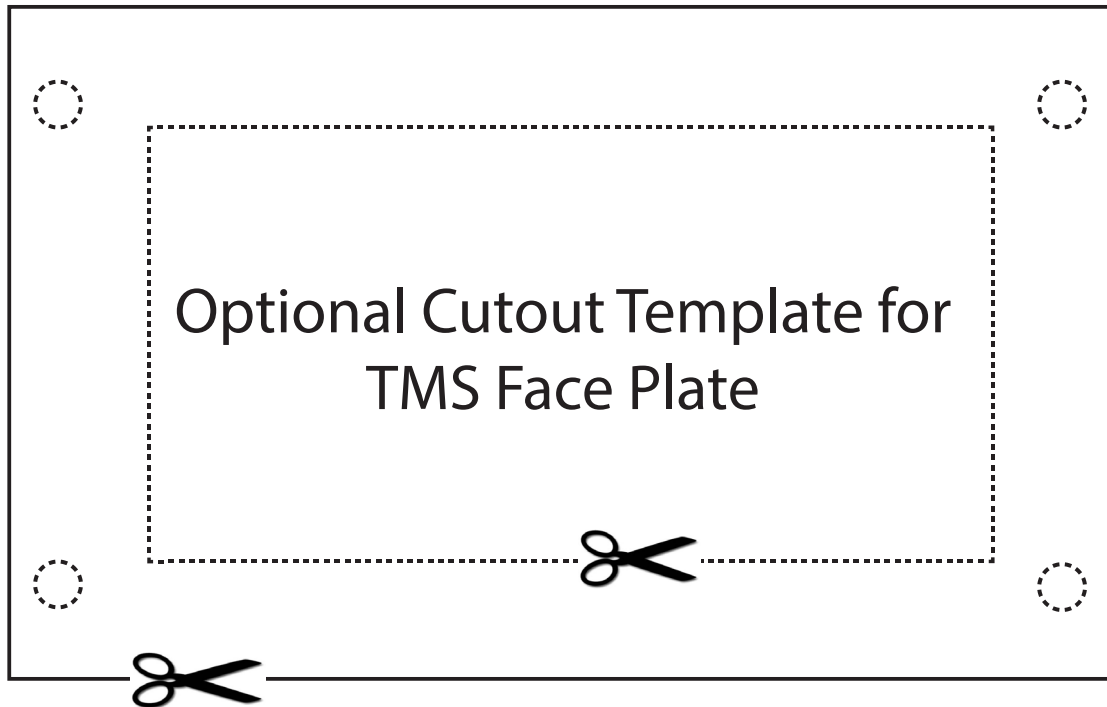

This fire pit instruction provides an option to mount the TPSI face plate to concrete board. Use the template above to complete the installation.

The TPSI face plate can be mounted vertically or horizontally. Our suggestion is to attach the face plate in a horizontal position with the gas valve on the left side. This allows the control knob text to be orientated in a position to be easily read.

Using scissors carefully cutout the template and trace it on your concrete board. The dotted line provides the cutout area to mount face plate. Use a concrete drill bit to drill (4) 3/16" diameter holes. Install the 1¼" black oxide screws through the front of the faceplate with the nuts and washers on the backside. These are all provided in the hardware bag.

CAUTION: Careful not to over-tighten screws and nuts to ensure the cement board does not crack or break.





Having problems getting the gas appliance to operate?
Don't leave the job site! We want to help! Call 800.966.8126 for
Technical Support between the hours of 8:00AM to 5:00PM PST.
BEFORE YOU CALL WE WILL NEED THIS INFORMATION

1. Model Number: _____
2. Serial Number: _____
3. How long is the gas line run? Nat Gas _____ LP Gas _____
4. What size is gas line? _____
5. Inlet Gas Pressure: _____ WC
Manifold Gas Pressure: _____ WC
6. What type of media are you using? _____
7. Review the troubleshooting section in the installation manual.
8. What are the symptoms? Please be prepared to explain.
9. Be prepared to send photos to us when on the phone.
10. Found missing or damaged parts? Let us know ASAP or send photos.

