

duraventTM

DuraChimney[®] II

Air-cooled chimney system for masonry fireplaces

UL 103



AV

Specifications

Applications

DuraChimney II is a double-wall, air-cooled chimney system for use with masonry fireplaces which burn wood, oil, coal, or gas.

Materials and Construction

.016" 430 stainless steel inner wall and .021" galvanized steel outer wall. For stainless steel outer wall, contact Customer Service for a quote.

Unitized pipe sections. No field assembly of inners and outers required.

Clearances

2" clearance to combustibles.

Shrouds

UL Listed with DuraVent shroud specifications. Information available online at www.duravent.com

Diameters

8", 10", 12", 14", and 16".

Listings

UL Listed to UL 103 and ULC S604 standards (MH7399).



UL 103 and ULC S604 System

DuraChimney II

DuraChimney II is an exceptional factory-built alternative to pre-fabricated masonry chimneys. DuraChimney II is a unitized, lightweight design which eliminates the need for field assembly of pipe sections, allowing for faster installation.

DuraChimney II is designed to stay cool on the outside, to provide a hot draft on the inside and to provide a fire-safe design that protects both the chimney and the building.

The double-wall, air-cooled design allows the chimney to expand both radially and lengthwise under high temperatures.

DuraChimney II is tested and listed for continuous operation at 1000°F flue gas temperatures, one hour at 1400°F and ten-minutes at 1700°F, in accordance with the UL 103 test standard.



Typical Installations

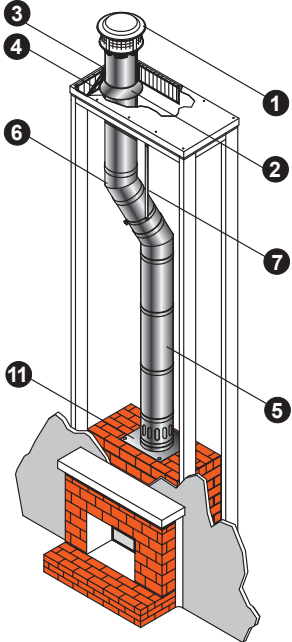

Masonry Firebox with Metal Chimney

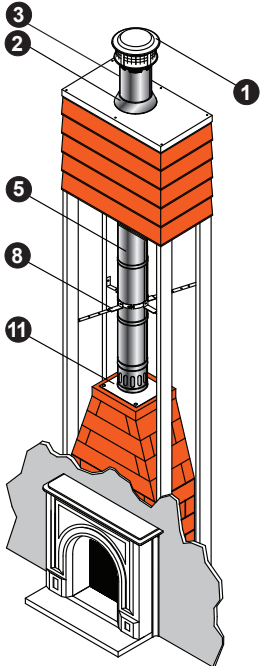

Prefabricated Masonry Fireplace Kit with Metal Chimney

| Installation Key | | | |
|------------------|-----------------------|----|--|
| 1 | Chimney Cap | 8 | Stabilizer |
| 2 | Storm Collar | 9 | Firestop |
| 3 | Chase Top Flashing | 10 | Attic Insulation Shield |
| 4 | Roof Radiation Shield | 11 | Anchor Plate/ Anchor Plate with Damper |
| 5 | Chimney Section | 12 | Supplementary Support |
| 6 | Elbow | 13 | Wall Strap |
| 7 | Elbow Strap | | |

Refer to our Typical Installation drawings to select the appropriate component parts for your installation.

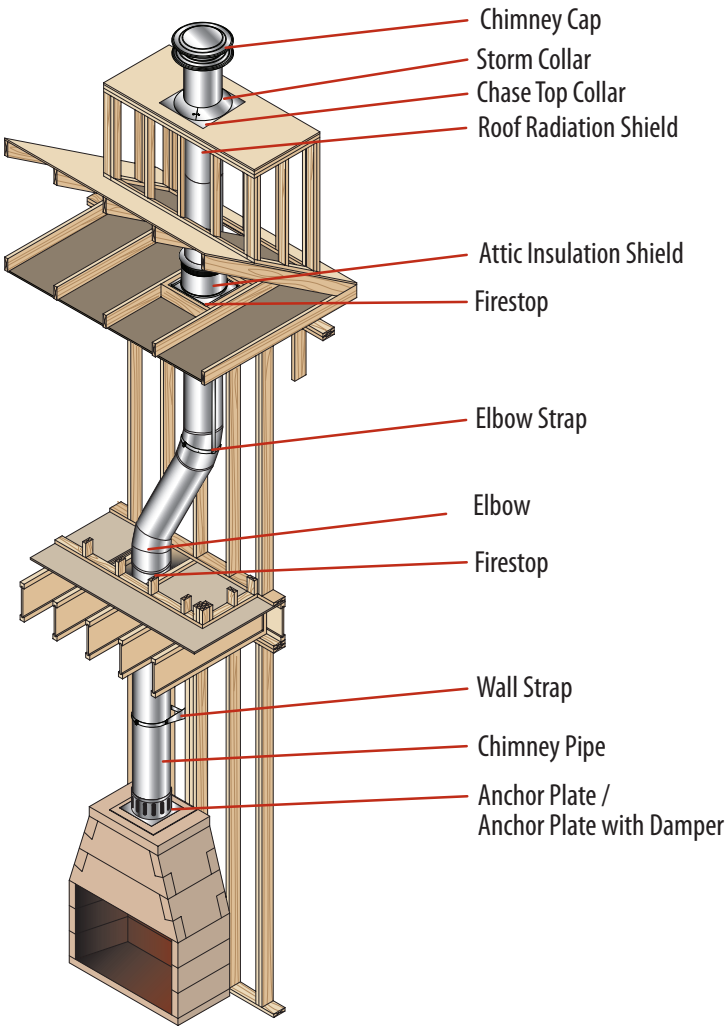

Planning Your Installation

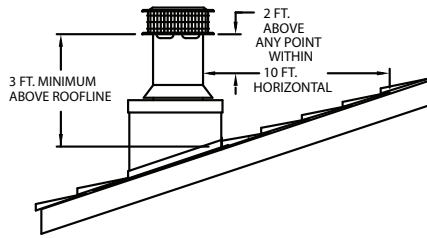
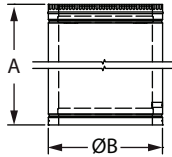

Figure 1

The following recommendations are a general guideline to assist in the layout and selection of the chimney components needed for your installation. Always follow Duravent Installation instructions enclosed with the cap or support box before installing your chimney system. Installation instructions can be viewed online at www.duravent.com, under catalogs > instructions.

- Measure the diameter of the fireplace flue outlet. An improperly sized chimney results in poor draft and excessive creosote formation.
- Select the chimney with the same size diameter as the fireplace flue outlet. Refer to the chimney sizing chart in the back of this catalog section for masonry fireplaces.
- Install the chimney in an enclosed chase.
- If possible, avoid offsets. A straight vertical installation is more efficient and less likely to develop creosote. If an offset is required to avoid rafters or other obstructions, measure the horizontal distance required and the vertical height available. Both 15° and 30° elbows are available. Elbows greater than 30° are not allowed in the United States. Two offsets (four elbows) in a single installation are permitted. Refer to the offset chart in the back of this catalog section. At least one Elbow Strap is required. Elbow Straps ensure adequate support.
- Determine the minimum chimney height above the roof line. Building codes require a minimum of 3' above the roof penetration and at least 2' higher than any portion of a building within 10'. See figure 1. The termination cap is installed above that point.
- A Chase Top Flashing is available. A pitched roof flashing can be locally made, if required. A storm collar is required for all installations using a flashing.
- Determine the total length of chimney required for the installation. To calculate the installed per length of 10"-16" DuraChimney II pipe, subtract 1" per joint. Minimum recommended chimney height, at sea level, of straight vertical chimney, is 10' to 15' above the fireplace outlet. Higher elevations, or the use of elbows, will require approximately 30% to 60% more height to provide for an adequate draft.
- For a UL approved shroud, see the DuraChimney II Shrouds Installation Instructions (L181). View online at www.duravent.com, under catalogs > instructions.
- Be fire safe. Maintain at least 2" clearance to combustibles. Follow local building codes and have your chimney inspected by a certified professional.

Chimney Pipe



DuraChimney II pipe is available in 12", 18", 36", and 48" lengths. To calculate the installed length of DuraChimney II pipe, subtract 1" from each length of chimney pipe.

For stainless steel outer wall, call Customer Service for quote and part number. DuraChimney II is built to order and is not returnable.

| SIZE | ORDER # | STOCK # | A | B |
|------|----------|-----------|-----|-----|
| 8" | 8DCA-12 | 810013678 | 12" | 12" |
| 8" | 8DCA-18 | 810013677 | 18" | 12" |
| 8" | 8DCA-24 | 810013676 | 24" | 12" |
| 8" | 8DCA-36 | 810013675 | 26" | 12" |
| 8" | 8DCA-48 | 810013674 | 48" | 12" |
| 10" | 10DCA-12 | 810000781 | 12" | 13" |
| 10" | 10DCA-18 | 810000782 | 18" | 13" |
| 10" | 10DCA-36 | 810000783 | 36" | 13" |
| 10" | 10DCA-48 | 810000784 | 48" | 13" |
| 12" | 12DCA-12 | 810000803 | 12" | 15" |
| 12" | 12DCA-18 | 810000804 | 18" | 15" |
| 12" | 12DCA-36 | 810000805 | 36" | 15" |
| 12" | 12DCA-48 | 810000806 | 48" | 15" |
| 14" | 14DCA-12 | 810000824 | 12" | 17" |
| 14" | 14DCA-18 | 810000825 | 18" | 17" |
| 14" | 14DCA-36 | 810000826 | 36" | 17" |
| 14" | 14DCA-48 | 810000827 | 48" | 17" |
| 16" | 16DCA-12 | 810000845 | 12" | 19" |
| 16" | 16DCA-18 | 810000846 | 18" | 19" |
| 16" | 16DCA-36 | 810000847 | 36" | 19" |
| 16" | 16DCA-48 | 810000848 | 48" | 19" |

15° Elbow

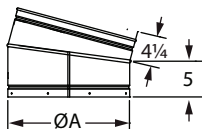

Use elbows to offset obstructions such as rafters, ridgepoles, or joists. 10"-16" DuraChimney II may have two pair of elbows, if needed. Offsets greater than 30° are not allowed. Elbows are not adjustable.

| SIZE | 10" | 12" | 14" | 16" |
|---------|-----------|-----------|-----------|-----------|
| A | 13" | 15" | 17" | 19" |
| ORDER # | 10DCA-E15 | 12DCA-E15 | 14DCA-E15 | 16DCA-E15 |
| STOCK # | 810000785 | 810000807 | 810000828 | 810000849 |

30° Elbow

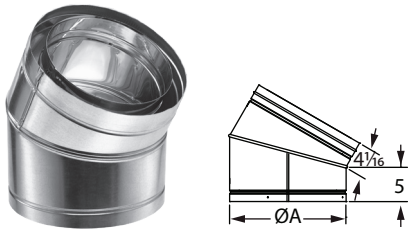

Use elbows to offset obstructions such as rafters, ridgepoles, or joists. 10"-16" DuraChimney II may have two pair of elbows, if needed. Offsets greater than 30° are not allowed. Elbows are not adjustable.

| SIZE | 10" | 12" | 14" | 16" |
|---------|-----------|-----------|-----------|-----------|
| A | 13" | 15" | 17" | 19" |
| ORDER # | 10DCA-E30 | 12DCA-E30 | 14DCA-E30 | 16DCA-E30 |
| STOCK # | 810000786 | 810000808 | 810000829 | 810000850 |

15° Elbow Kit



The 8" DuraChimney II Elbow Kits include 2 elbows and 1 elbow strap. Use to offset around obstructions such as rafters, ride poles, or joists. Offsets greater than 30° is not allowed. Elbows are not adjustable.

| 15° | 8" |
|---------|-----------|
| A | 12" |
| ORDER # | 8DCA-E15K |
| STOCK # | 810013697 |

30° Elbow Kit



The 8" DuraChimney II Elbow Kits include 2 elbows and 1 elbow strap. Use to offset around obstructions such as rafters, ride poles, or joists. Offsets greater than 30° is not allowed. Elbows are not adjustable.

| 30° | 8" |
|---------|-----------|
| A | 12" |
| ORDER # | 8DCA-E30K |
| STOCK # | 810013679 |

Elbow Strap

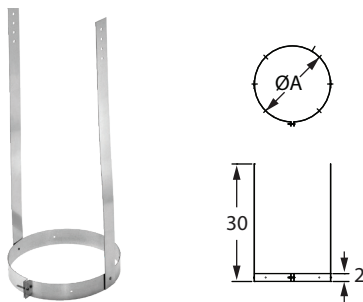

Use between two elbows to support the weight of the chimney.

| SIZE | 8" | 10" | 12" | 14" | 16" |
|---------|-----------|-----------|-----------|-----------|-----------|
| A | 12 3/8" | 13 3/8" | 15 3/8" | 17 3/8" | 19 3/8" |
| ORDER # | 8DCA-ES | 10DCA-ES | 12DCA-ES | 14DCA-ES | 16DCA-ES |
| STOCK # | 810013698 | 810000787 | 810000809 | 810000830 | 810000851 |

Supplementary Support

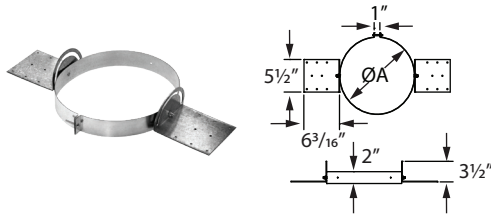

Use to help support the weight of DuraChimney II. Supports a maximum of 25' of chimney. Use additional Supplementary Supports as needed.

| SIZE | 8" | 10" | 12" | 14" | 16" |
|---------|-----------|-----------|-----------|-----------|-----------|
| A | 12 3/8" | 13 3/8" | 15 3/8" | 17 3/8" | 19 3/8" |
| ORDER # | 8DCA-SS | 10DCA-SS | 12DCA-SS | 14DCA-SS | 16DCA-SS |
| STOCK # | 810013699 | 810000788 | 810000810 | 810000831 | 810000852 |

Wall Strap

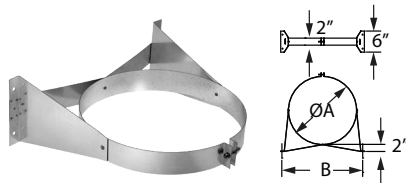

Use to support and to stabilize the chimney in interior or exterior installations to ensure a 2" clearance. Wall Straps are required every 8' on exterior of the building only.

| SIZE | 8" | 10" | 12" | 14" | 16" |
|---------|-----------|-----------|-----------|-----------|-----------|
| A | 12 3/8" | 13 3/8" | 15 3/8" | 17 3/8" | 19 3/8" |
| B | 15 3/4" | 15 15/16" | 18 1/8" | 20 3/8" | 22 1/16" |
| ORDER # | 8DCA-WS | 10DCA-WS | 12DCA-WS | 14DCA-WS | 16DCA-WS |
| STOCK # | 810013700 | 810000800 | 810000821 | 810000842 | 810000863 |

Stabilizer

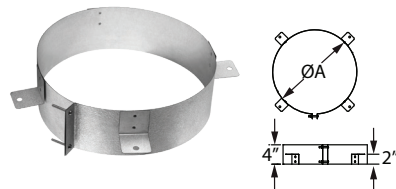

Use to hold DuraChimney II in place. Use inside chase enclosures to stabilize the chimney. Refer to the fireplace manufacturer for additional requirements on the use of Stabilizer.

| SIZE | 8" | 10" | 12" | 14" | 16" |
|---------|-----------|-----------|-----------|-----------|-----------|
| A | 12 3/8" | 13 3/8" | 15 3/8" | 17 3/8" | 19 3/8" |
| ORDER # | 8DCA-ST | 10DCA-ST | 12DCA-ST | 14DCA-ST | 16DCA-ST |
| STOCK # | 810013701 | 810000789 | 810000813 | 810000832 | 810000853 |

Anchor Plate

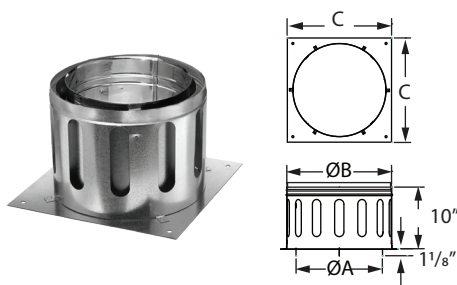

Use as a starter section for DuraChimney II. Bolts directly to the fireplace outlet.

| SIZE | 8" | 10" | 12" | 14" | 16" |
|---------|-----------|-----------|-----------|-----------|-----------|
| A | 8" | 10" | 12" | 14" | 16" |
| B | 12" | 13" | 15" | 17" | 19" |
| C | 14" | 15" | 17" | 19" | 21" |
| ORDER # | 8DCA-AP | 10DCA-AP | 12DCA-AP | 14DCA-AP | 16DCA-AP |
| STOCK # | 810013686 | 810000790 | 810000811 | 810000833 | 810000854 |

Anchor Plate w/ Damper

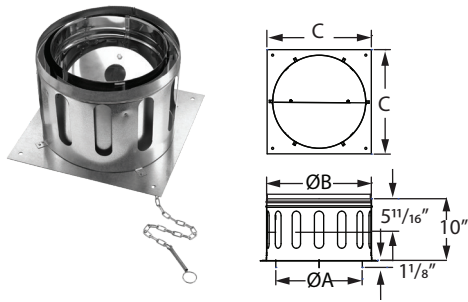

Use as a starter section for DuraChimney II. Bolts directly to the fireplace outlet. Damper section allows the chimney to be closed when the fireplace is not in use. Includes chain and lintel hook.

| SIZE | 10" | 12" | 14" | 16" |
|---------|-----------|-----------|-----------|-----------|
| A | 10" | 12" | 14" | 16" |
| B | 13" | 15" | 17" | 19" |
| C | 15" | 17" | 19" | 21" |
| ORDER # | 10DCA-APD | 12DCA-APD | 14DCA-APD | 16DCA-APD |
| STOCK # | 810000791 | 810000812 | 810000834 | 810000855 |

Firestop

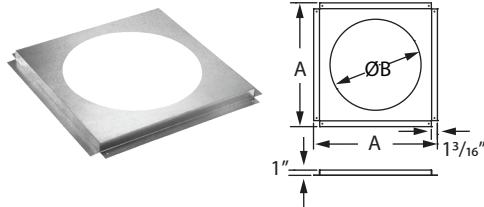

Use in ceiling/floor penetrations above fireplace. A Firestop is not required when passing through the roof. Fits on the underside of ceiling.

| SIZE | 8" | 10" | 12" | 14" | 16" |
|---------|-----------|-----------|-----------|-----------|-----------|
| A | 17 7/8" | 19 5/8" | 21 5/8" | 23 5/8" | 25 5/8" |
| B | 12 3/8" | 13 3/8" | 15 3/8" | 17 3/8" | 19 3/8" |
| ORDER # | 8DCA-FS | 10DCA-FS | 12DCA-FS | 14DCA-FS | 16DCA-FS |
| STOCK # | 810013680 | 810000792 | 810000814 | 810000835 | 810000856 |

30° Firestop

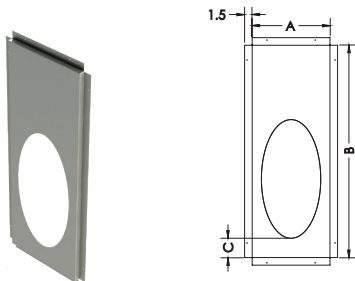

Designed for use when the chimney passes through a wall at a 30° angle from the vertical.

| SIZE | 8" |
|---------|-----------|
| A | 16" |
| B | 43 1/2" |
| C | 4" |
| ORDER # | 8DCA-FS30 |
| STOCK # | 810013681 |

Attic Insulation Shield

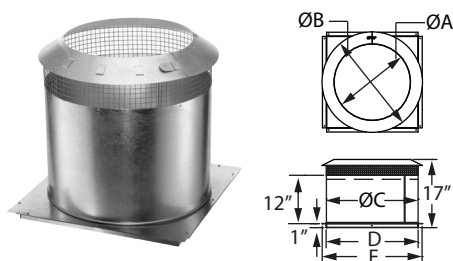

Use in all installations that pass through an attic to prevent insulation and debris from accumulating near the chimney, unless the chimney is enclosed through attic. Consists of two parts – a collar and a base.

| SIZE | 8" | 10" | 12" | 14" | 16" |
|---------|-----------|-----------|-----------|-----------|-----------|
| A | 12" | 13" | 15" | 17" | 19" |
| B | 16" | 17" | 19" | 21" | 29" |
| C | 15 13/16" | 16 13/16" | 18 13/16" | 20 13/16" | 22 13/16" |
| D | 15 7/8" | 16 7/8" | 18 7/8" | 20 7/8" | 22 7/8" |
| E | 17 13/16" | 18 13/16" | 20 13/16" | 22 13/16" | 24 13/16" |
| ORDER # | 8DCA-IS | 10DCA-IS | 12DCA-IS | 14DCA-IS | 16DCA-IS |
| STOCK # | 810013703 | 810000793 | 810000815 | 810000836 | 810000857 |

Roof Radiation Shield

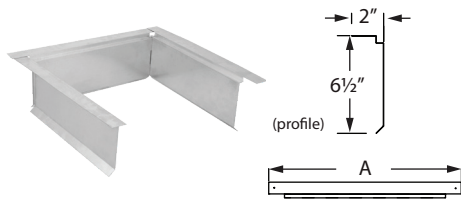

Required at the top of chase enclosure or where the chimney passes through the roof. A Roof Radiation Shield is not required if the chimney is unenclosed in the attic. Four plates (included) make up one shield. Three of the four plates shown.

| SIZE | 8" | 10" | 12" | 14" | 16" |
|---------|-----------|-----------|-----------|-----------|-----------|
| A | 19" | 20" | 22" | 24" | 26" |
| ORDER # | 8DCA-RRS | 10DCA-RRS | 12DCA-RRS | 14DCA-RRS | 16DCA-RRS |
| STOCK # | 810013704 | 810000794 | 810000816 | 810000837 | 810000858 |

Chase Top Flashing

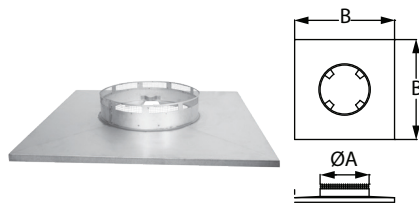

Encloses the top of a chase while providing a ventilation air passage to the chase. Includes spacer clips.

| SIZE | 8" | 10" | 12" | 14" | 16" |
|---------|-----------|-----------|-----------|-----------|-----------|
| A | 15" | 16" | 18" | 20" | 22" |
| B | 34" | 20" | 36" | 38" | 40" |
| ORDER # | 8DCA-CTF | 10DCA-CTF | 12DCA-CTF | 14DCA-CTF | 16DCA-CTF |
| STOCK # | 810013705 | 810000795 | 810000817 | 810000838 | 810000859 |

Chase Top Collar

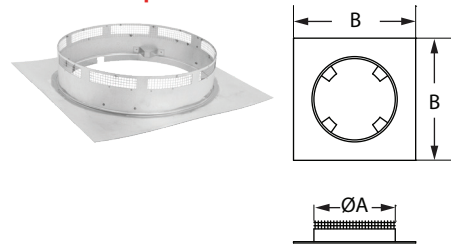

Use to construct custom sized chase tops. Provides necessary ventilation and spacing to maintain UL listing for chimney system.

| SIZE | 8" | 10" | 12" | 14" | 16" |
|---------|-----------|-----------|-----------|-----------|-----------|
| A | 15" | 16" | 18" | 20" | 22" |
| B | 20" | 20" | 22" | 24" | 26" |
| ORDER # | 8DCA-CTC | 10DCA-CTC | 12DCA-CTC | 14DCA-CTC | 16DCA-CTC |
| STOCK # | 810013706 | 810000796 | 810000818 | 810000839 | 810000860 |

Storm Collar



Use to help prevent rain from entering the chase. Use with a flashing and a Chimney Cap.

| SIZE | 8" | 10" | 12" | 14" | 16" |
|---------|-----------|-----------|-----------|-----------|-----------|
| A | 12" | 13" | 15" | 17" | 19" |
| ORDER # | 8DCA-SC | 10DCA-SC | 12DCA-SC | 14DCA-SC | 16DCA-SC |
| STOCK # | 810013682 | 810000798 | 810000820 | 810000841 | 810000862 |

Chimney Cap

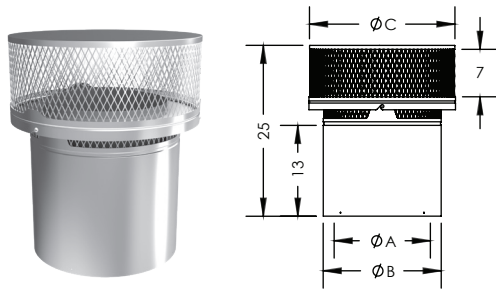

Use to terminate the chimney system. Required on all installations. Slides over the previous section of DuraChimney II pipe to allow for chimney height adjustment. Includes a Spark Arrestor.

For stainless steel outer wall, call Customer Service. DuraChimney II is built to order and is not returnable.

| SIZE | 10" | 12" | 14" | 16" |
|---------|-----------|-----------|-----------|-----------|
| A | 10" | 12" | 14" | 16" |
| B | 13" | 15" | 17" | 19" |
| C | 18" | 21" | 21" | 23" |
| ORDER # | 10DCA-VC1 | 12DCA-VC1 | 14DCA-VC1 | 16DCA-VC1 |
| STOCK # | 810014049 | 810014050 | 810014051 | 810014052 |

8" Chimney Cap

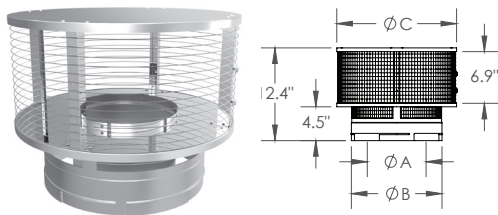

Use to terminate the chimney system. Required on all installations. Slides over the previous section of DuraChimney II pipe to allow for chimney height adjustment. Includes a Spark Arrestor.

For stainless steel outer wall, call Customer Service. DuraChimney II is built to order and is not returnable.

| SIZE | 8" |
|---------|-----------|
| A | 7 9/16" |
| B | 12" |
| C | 16" |
| ORDER # | 8DCA-VC |
| STOCK # | 810013683 |

Roof Flashing

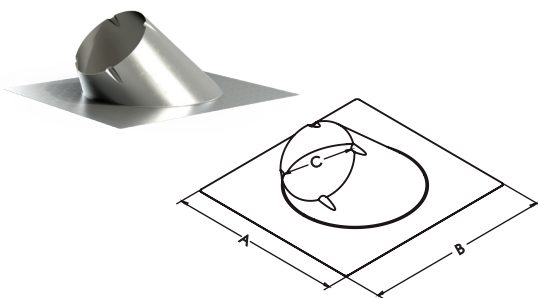

Use to weather proof the penetration of the chimney pipe through the roof. Storm collar required. Select a roof flashing based on the pitch of the roof. For example, a 6/12 pitch has a vertical rise of 6" over a horizontal distance of 12".

| SIZE | | 8" | SIZE | | 8" |
|----------------------|---------|-----------|-----------------------|---------|-----------|
| 0/12 - 6/12 PITCH | A | 26" | 7/12 - 12/12 PITCH | A | 33 1/2" |
| | B | 26" | | B | 36" |
| | C | 12" | | C | 12" |
| | ORDER # | 8DCA-F6 | | ORDER # | 8DCA-F12 |
| | STOCK # | 810013684 | | STOCK # | 810013685 |

European Copper Adapter - King Model

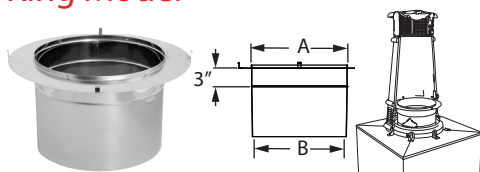

Use for installing the European Copper Chimney Pots King model shroud/pot onto DuraChimney II chimney.

| SIZE | 10" | 12" | 14" |
|---------|-----------|-----------|-----------|
| A | 10" | 12" | 14" |
| B | 9 1/2" | 11 1/2" | 13 1/2" |
| ORDER # | 10DCA-ECK | 12DCA-ECK | 14DCA-ECK |
| STOCK # | 810000801 | 810000822 | 810000843 |

European Copper Adapter - Bishop Model

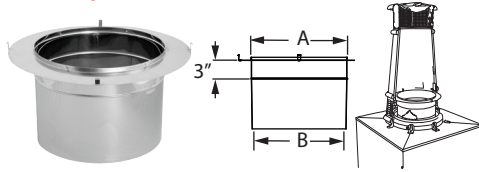

Use for installing the European Copper Chimney Pots Bishop model shroud/pot onto DuraChimney II chimney. King model shown.

| SIZE | 10" | 12" | 14" | 16" |
|---------|-----------|-----------|-----------|-----------|
| A | 10" | 12" | 14" | 16" |
| B | 9 1/2" | 11 1/2" | 13 1/2" | 15 1/2" |
| ORDER # | 10DCA-ECB | 12DCA-ECB | 14DCA-ECB | 16DCA-ECB |
| STOCK # | 810000802 | 810000823 | 810000844 | 810000864 |

Snow Splitter

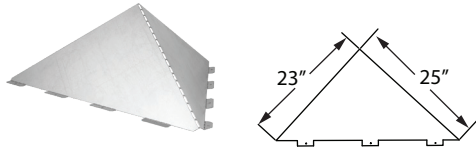

Use to divert snow around chimney, vent, and roof flashing. Constructed of paintable galvanized material. Ships flat for easy assembly.

| SIZE | 6" |
|---------|-----------|
| ORDER # | 6DT-SP |
| STOCK # | 810000139 |

Elbow Offset Chart

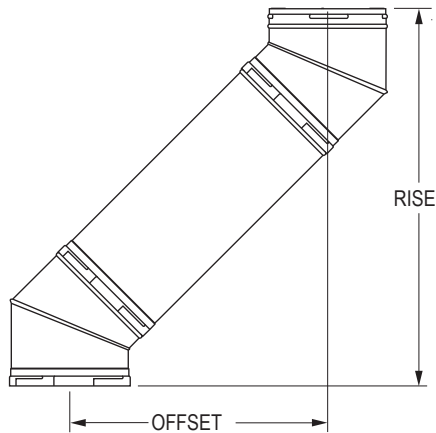

| Elbow Angle From Vertical | Chimney Length Between Elbows | Size 10" I.D. | | Size 12" I.D. | | Size 14" I.D. | | Size 16" I.D. | |
|---------------------------|-------------------------------|---------------|-------------|---------------|-------------|---------------|-------------|---------------|-------------|
| | | Offset Inches | Rise Inches | Offset Inches | Rise Inches | Offset Inches | Rise Inches | Offset Inches | Rise Inches |
| 15° | 0" | 2 9/16" | 20 3/8" | 2 3/8" | 21 5/8" | 2 5/8" | 21 5/8" | 2 3/4" | 21 1/8" |
| 15° | 12" | 5 3/8" | 31 1/4" | 5 1/2" | 31 3/4" | 5 1/2" | 32 1/4" | 5 5/8" | 32 3/4" |
| 15° | 18" | 7" | 37" | 7" | 37 1/2" | 7 1/8" | 38" | 7 1/8" | 36 1/2" |
| 15° | 36" | 11 5/8" | 54 1/2" | 11 5/8" | 55" | 11 3/4" | 55 3/8" | 11 3/4" | 55 7/8" |
| 15° | 48" | 14 3/4" | 66" | 14 3/4" | 66 1/2" | 14 7/8" | 67" | 14 7/8" | 67 1/2" |
| 30° | 0" | 5 3/4" | 22 3/8" | 6" | 22 3/8" | 6 1/4" | 24 1/2" | 6 5/8" | 25 1/2" |
| 30° | 12" | 11 1/4" | 32" | 11 1/2" | 33" | 11 3/4" | 34" | 12" | 35 1/2" |
| 30° | 18" | 14 1/4" | 37 1/8" | 14 1/2" | 38 1/8" | 14 3/4" | 39 1/4" | 15" | 40 5/8" |
| 30° | 36" | 23 1/4" | 52 3/4" | 23 1/2" | 53 3/4" | 23 3/4" | 54 7/8" | 24" | 56 1/4" |
| 30° | 48" | 29 1/4" | 63 1/8" | 29 1/2" | 64 1/8" | 29 3/4" | 65 1/4" | 30" | 66 5/8" |

Chimney Sizing Chart for Fireplace Installations

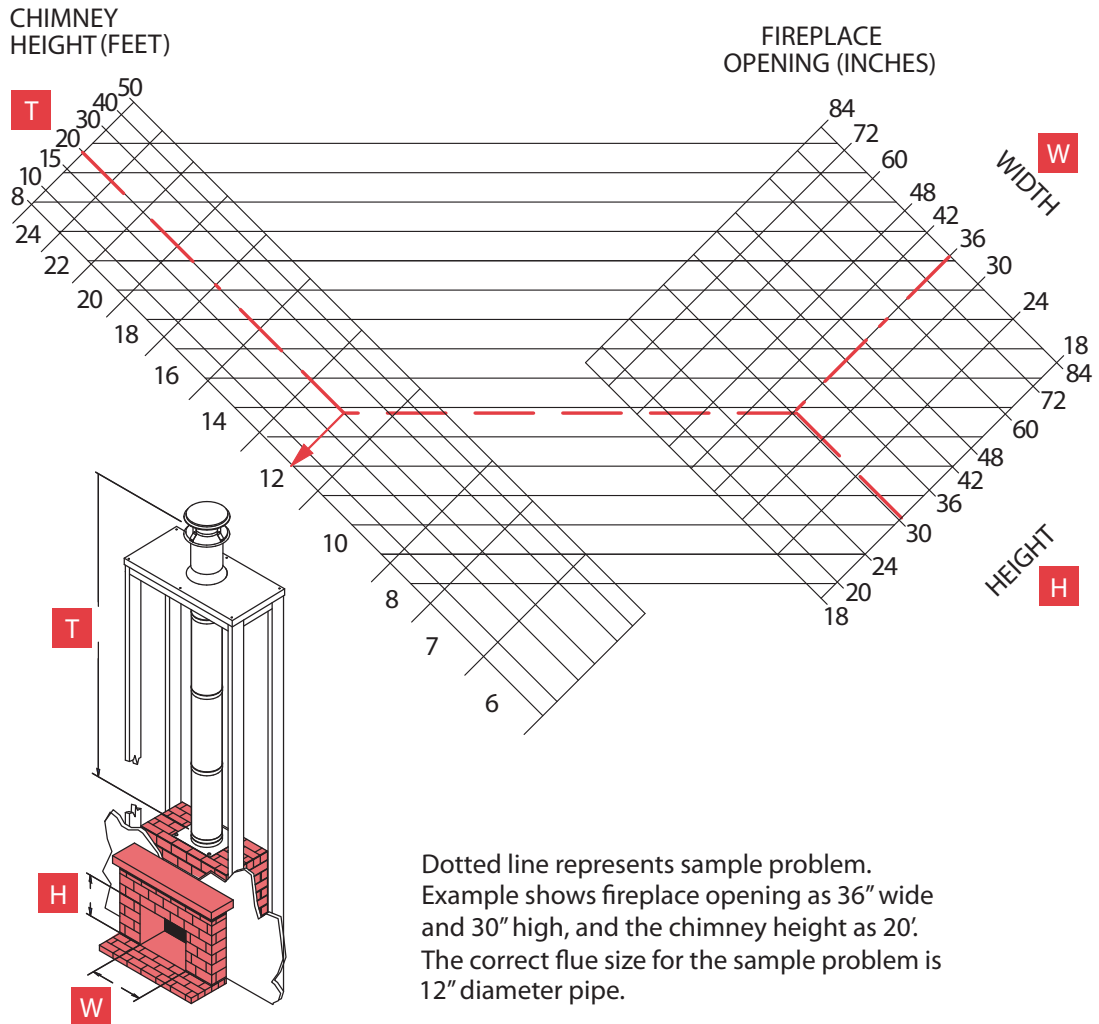



BUILD FOR THE FUTURE

Customer Service and Support:

| | |
|-------------------------------------|--------------|
| Airmate (USA)..... | 800.992.8368 |
| Airmate (CAN) | 888.735.5475 |
| Ameriflow | 800.252.8467 |
| Amerivent (Retail)..... | 800.252.8467 |
| Amerivent (Hearth & Wholesale) | 800.423.4270 |
| Amerivent (Support)..... | 800.748.0392 |
| AMPCO (USA) | 800.669.3269 |
| AMPCO (CAN)..... | 888.735.5475 |
| Duravent | 800.835.4429 |
| Hart & Cooley..... | 800.433.6341 |
| Hart & Cooley (Support) | 800.748.0392 |
| Heatfab (USA)..... | 800.772.0739 |
| Heatfab (CAN) | 800.848.2149 |
| Lima..... | 800.423.4270 |
| Milcor | 800.774.5240 |
| Portals Plus..... | 800.774.5240 |
| RPS..... | 800.624.8642 |
| Security Chimney (USA)..... | 800.361.4909 |
| Security Chimney (CAN) | 800.667.3387 |
| Selkirk (USA) Residential | 800.992.8368 |
| Selkirk (USA) Commercial..... | 800.848.2149 |
| Selkirk (USA) Support..... | 800.748.0392 |
| Selkirk (CAN) | 888.735.5475 |

Manufacturing & Distribution Centers:

| | |
|------------------|------------------------------|
| CANADA | |
| Nobel, ON | Manufacturing |
| Laval, QC | Manufacturing |
| Prescott, ON | Distribution |
| USA | |
| Grand Rapids, MI | Center of Excellence |
| Dallas, TX | Distribution |
| Englewood, OH | Distribution |
| Huntsville, AL | Manufacturing & Distribution |
| Mira Loma, CA | Distribution |
| Nampa, ID | Manufacturing & Distribution |
| Turner Falls, MA | Manufacturing & Distribution |
| Vacaville, CA | Manufacturing |
| MEXICO | |
| Ojinaga, MX | Manufacturing |
| Mexicali, MX | Manufacturing |

Corporate Headquarters:

Duravent Group
 28 W. Adams, Suite 1810
 Detroit, MI 48226
 Tel: 800.835.4429
 Email: info@duraventgroup.com
www.duraventgroup.com

duravent[™]

duravent[™]
GROUP

BUILD FOR THE FUTURE

www.duraventgroup.com

