



**BROMIC**<sup>®</sup>  
HEATING



SEAMLESS INTEGRATION OF  
MODERN CLEAN LINES, MINIMALISTIC  
DESIGN AND QUALITY MATERIALS  
ACHIEVES INNOVATIVE STYLING AND  
TECHNICAL PERFORMANCE.

---

BRÖMIC

PLATINUM SMART-HEAT™ ELECTRIC  
WITH OPTIONAL RECESS KIT

PLATINUM  
SMART-HEAT™ ELECTRIC

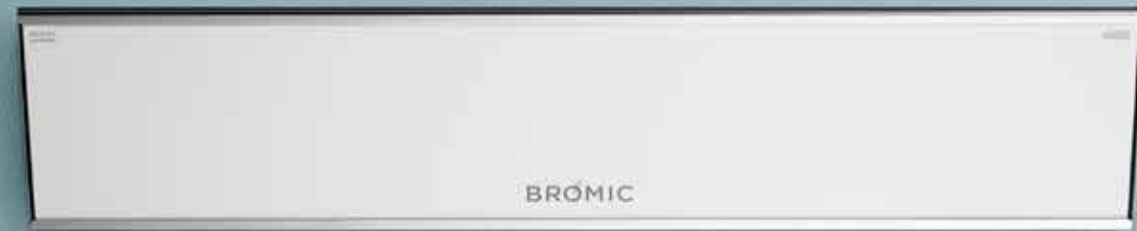

Available in black and white, our Platinum Smart-Heat™ Electric heater is specifically suited for low-clearance and design-focused spaces. This slim-line, stainless-steel unit spreads comfort evenly, all while minimizing light emission and blending seamlessly into the background with our recess mounting solutions.





PLATINUM  
SMART-HEAT™ GAS

---



The Platinum Smart-Heat™ Gas heater series spreads heat and comfort evenly in all areas, with a soft and soothing red glow. Built with pure premium materials and designed with elegance, there is no compromise on performance, reliability and beauty.



TUNGSTEN  
SMART-HEAT™ ELECTRIC

---

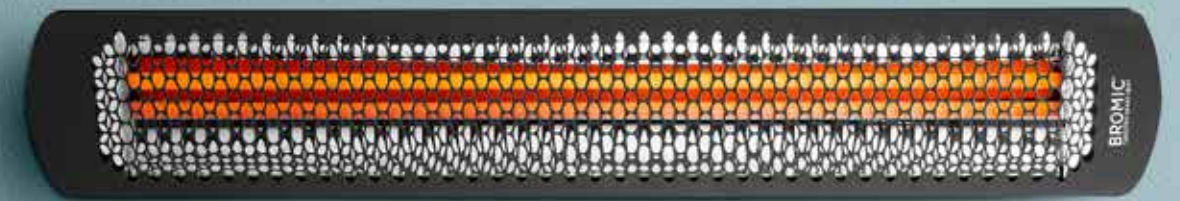

Our Tungsten Smart-Heat™ Electric series offers high performance radiant heating for outdoor and semi-enclosed spaces alike, with an industrial design style. It also boasts a high-temperature coating to suit all environments. With a stainless-steel construction, its durable element will emit a soft red glow to create a warm ambience in your space.





TUNGSTEN  
SMART-HEAT™ GAS

---

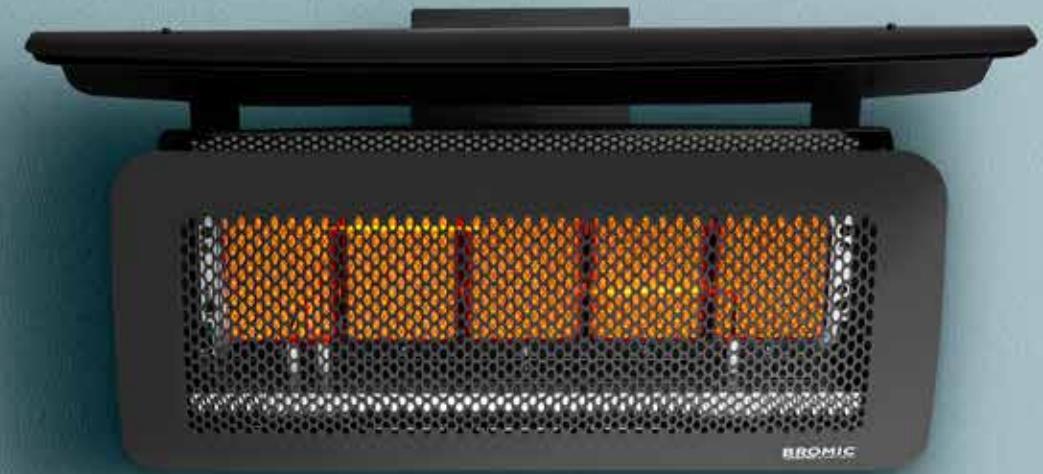

Our Tungsten Smart-Heat™ Gas heater has a durable, soft flowing curved facia and engineered body, which produces formidable heat to create a truly comfortable outdoor space. Its easy pivot arm allows for greater positioning and directional heat control. This heater also has a range of accessories available to provide versatility in mounting & controller options.





EXTEND YOUR COMFORT OUTDOORS  
WITH THE SUPERIOR HEAT AND  
AWARD-WINNING DESIGN OF OUR  
SMART-HEAT™ OUTDOOR HEATERS.





## TUNGSTEN SMART-HEAT™ PORTABLE

---

Its neutral black finish and award-winning design make it a piece of modern art. The Tungsten Smart-Heat™ Portable heater offers efficient directional heat and is a versatile heating solution for any outdoor settings. Its modular construction with built-in wheels allows for easy maneuverability in tighter spaces.

**SWITCH ON.  
GO WIRELESS.**

## SMART-HEAT™ WIRELESS CONTROLLERS

With the option to connect groups of heaters from a single point as well as dimming heating outputs, the Smart-Heat™ range of controllers provide a simple, yet powerful solution to controlling your environment.

Learn more about our wireless control options  
[bromic.com/gowireless](https://bromic.com/gowireless)



### ON | OFF 4-CHANNEL REMOTE (GAS & ELECTRIC)

The Bromic Smart-Heat Wireless On | Off Controller can switch power supply to two separate outputs, enabling independent 'On | Off' wireless control.



### DIMMER CONTROLLER (ELECTRIC ONLY)

The Bromic Smart-Heat Wireless Dimmer Controller allows you to adjust the heat from 1-100% for perfect comfort and complete flexibility.

\*Please contact a Bromic heating specialist to discuss the ideal solution for your outdoor space. Our free design service includes wiring diagrams for set up options.



# PLATINUM SMART-HEAT™ GAS

MODEL NUMBER	300 SERIES	500 SERIES
PRODUCT CODE	BH0110002-1   BH0110001-1	BH0110004-1   BH0110003-1
FUEL TYPE	LPG   NG	LPG   NG
COLOR	BLACK   STAINLESS	BLACK   STAINLESS
HEAT AREA	160FT	215FT
RATED CURRENT	110V/2A	110V/2A
MINIMUM FLOOR CLEARANCE	96"	96"
OUTPUT	23,600 BTU	39,800 BTU

MOUNTING OPTIONS	300 SERIES	500 SERIES
CEILING MOUNT	✓	✓
WALL MOUNT	✓	✓
RECESSED   FLUSH MOUNT	-	-
CEILING POLE MOUNT	✓	✓
FREESTANDING	-	-

CONTROL OPTIONS	300 SERIES	500 SERIES
ON   OFF	✓	✓
ON   OFF PRODUCT CODE	BH3130010-1	BH3130010-1
DIMMER	-	-
MASTER REMOTE	-	-

Measurements displayed within this catalogue are minimum requirements for installation. Bromic takes no responsibility for incorrect or non-compliant installations. All measurement in this catalogue are displayed in inches.

## PRODUCT MEASUREMENTS

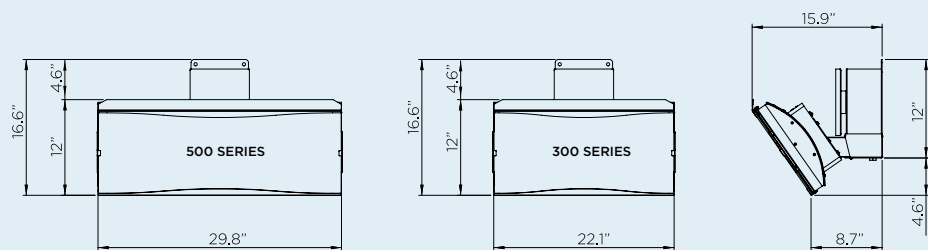

## PRODUCT MEASUREMENTS WITH HEAT DEFLECTOR

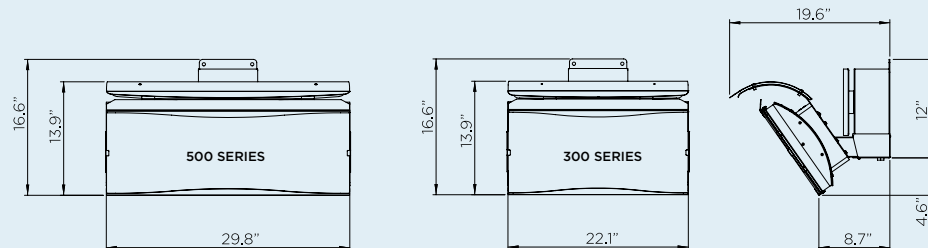

## CEILING & WALL MOUNT CLEARANCE

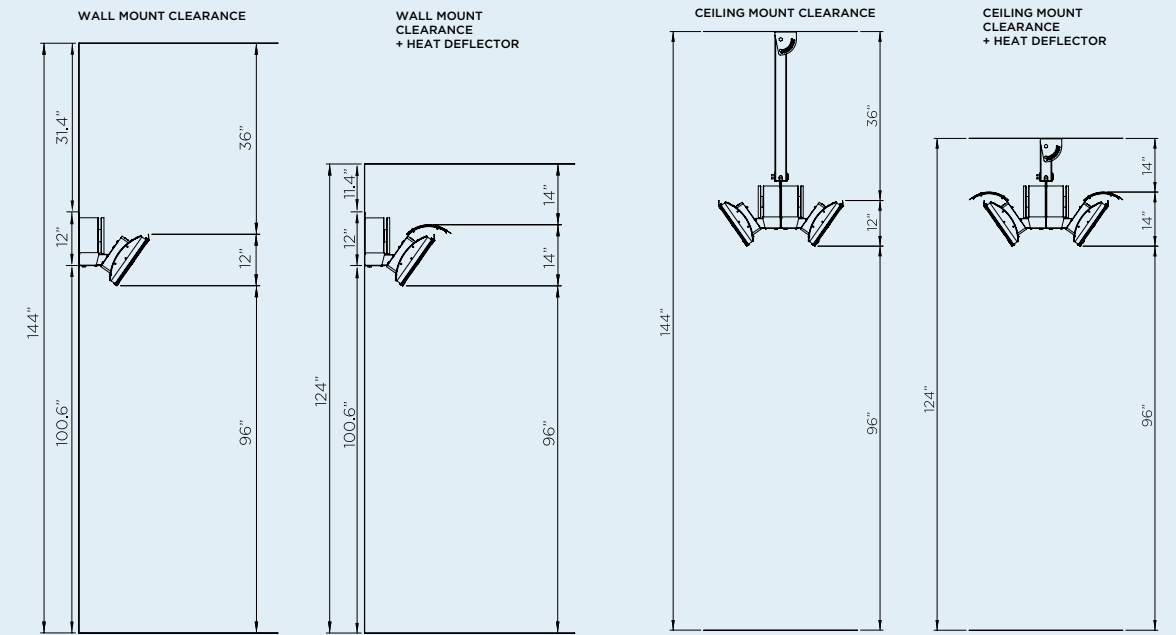

## WALL BRACKET

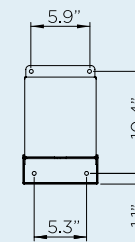

## HEAT AREA

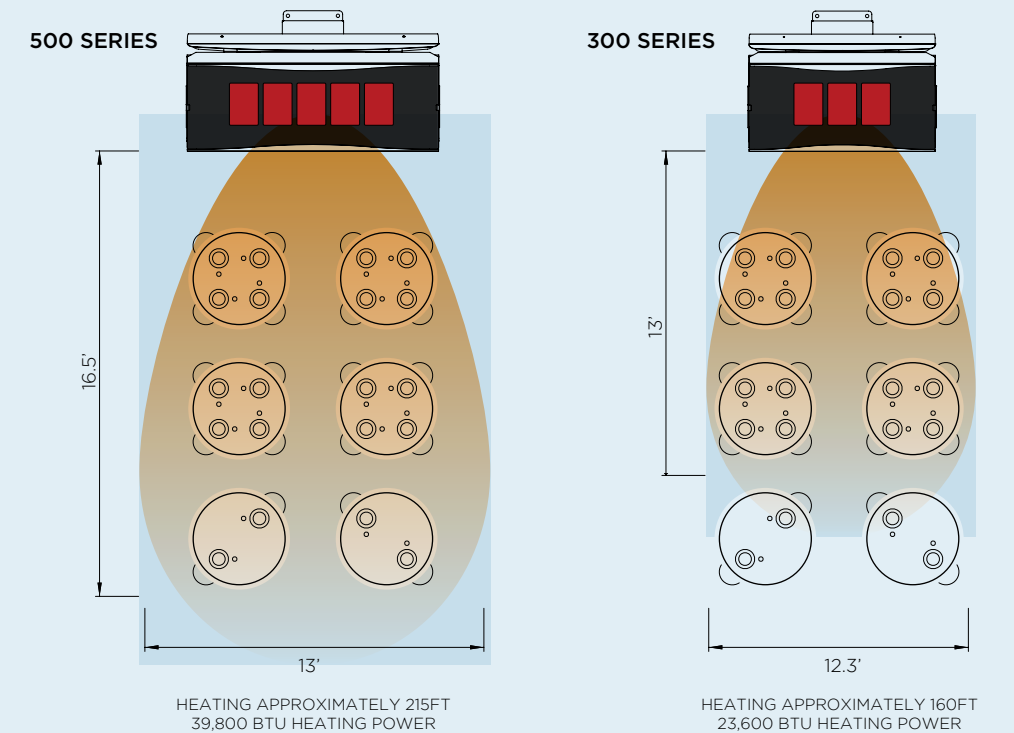



# PLATINUM SMART-HEAT™ ELECTRIC

MODEL NUMBER	2300W SERIES	3400W SERIES
PRODUCT CODES	BH0320003   BH0320007	BH0320005   BH0320008
FUEL TYPE	ELECTRIC	ELECTRIC
COLOR	BLACK   WHITE	BLACK   WHITE
HEAT AREA	65FT	108FT
RATED CURRENT	230 - 240V/9.6A	230 - 240V/14.2A
MINIMUM FLOOR CLEARANCE	WALL 72"   CEILING 96"	WALL 72"   CEILING 96"

MOUNTING OPTIONS		
CEILING MOUNT	✓	✓
CEILING RECESS KIT PRODUCT CODES	BH3130017	BH3130027
WALL MOUNT	✓	✓
RECESSED   FLUSH MOUNT	✓	✓
CEILING POLE MOUNT	✓	✓
CEILING POLE (2') PRODUCT CODE	BH3130023	BH3130023
CEILING POLE (4') PRODUCT CODE	BH3130024	BH3130024
FREESTANDING	-	-

CONTROL OPTIONS		
ON   OFF	✓	✓
ON   OFF PRODUCT CODE	BH3130010-1	BH3130010-1
DIMMER	✓	✓
DIMMER PRODUCT CODE	BH3130011-1	BH3130011-1
MASTER REMOTE *	✓	✓

Measurements displayed within this document are minimum requirements for installation. Bromic takes no responsibility for incorrect or non-compliant installations. All measurement in this document are displayed in inches.

\* Control up to six zones of heaters with unlimited heaters per zone from a single control. Works with dimming and on/off controllers. Control operates within 100ft of heaters. \*\* Available in varying voltages: 220/240v

## PRODUCT MEASUREMENTS

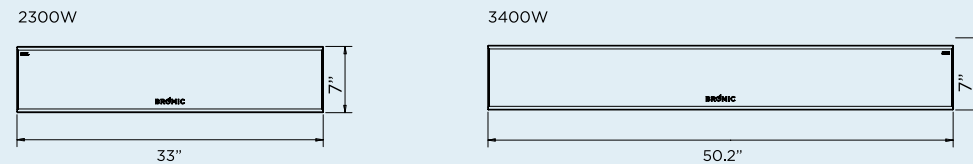

## CEILING RECESS KIT

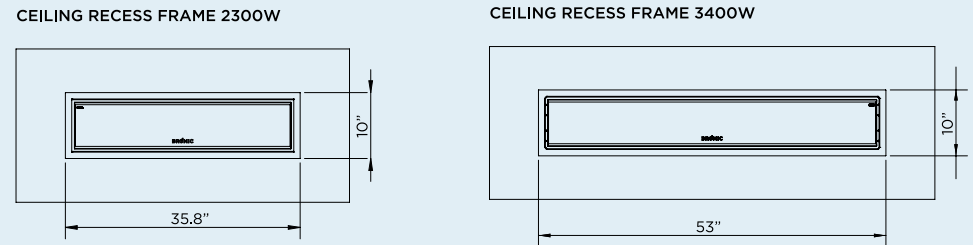

## CEILING CAVITY GUIDE

MINIMUM CAVITY SIZE FOR BOTH 2300W & 3400W MODELS

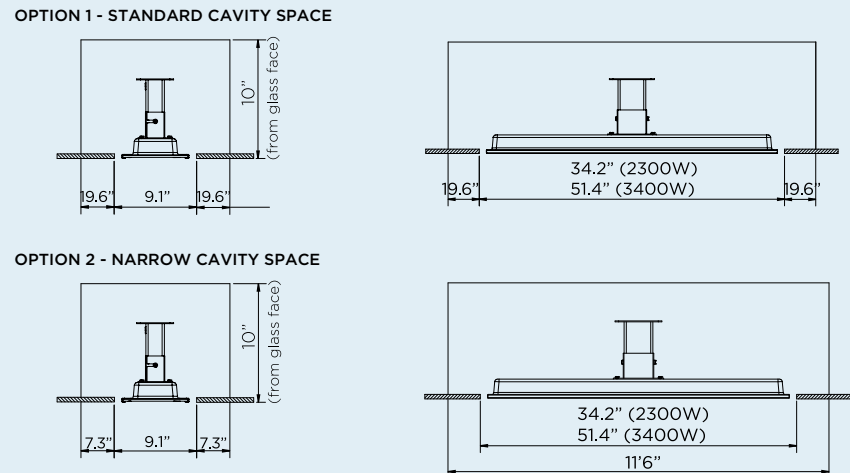

## CEILING & WALL MOUNT CLEARANCE

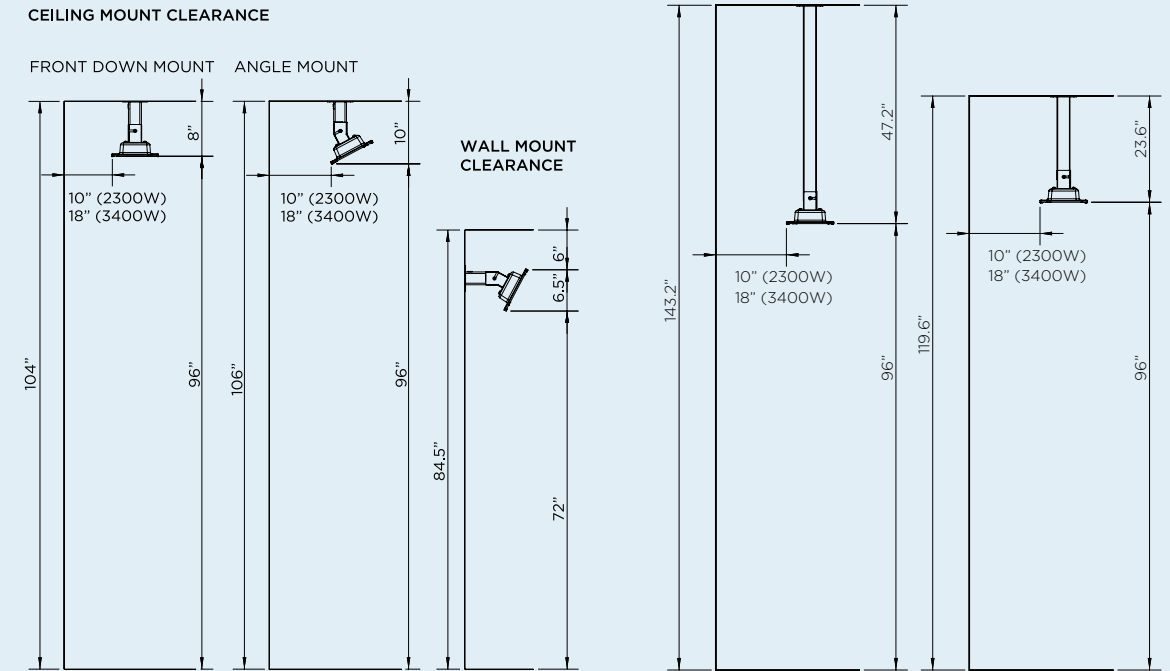

## WALL BRACKET (INCLUDED)

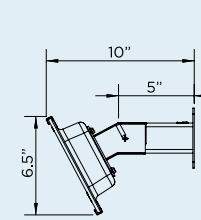

## CEILING BRACKET (INCLUDED)

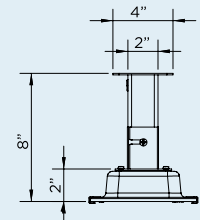

## HEAT AREA

**2300W SERIES**  
HEATING APPROXIMATELY 65FT  
2300W HEATING POWER

**3400W SERIES**  
HEATING APPROXIMATELY 108FT  
3400W HEATING POWER

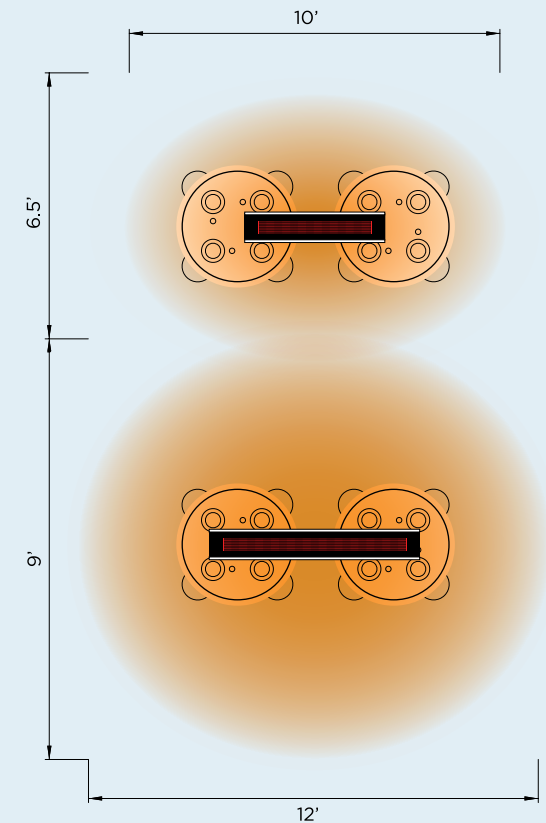

# TUNGSTEN SMART-HEAT™ GAS

MODEL NUMBER	300 SERIES	500 SERIES
PRODUCT CODE	BH0210002-1   BH0210001-1	BH0210004-1   BH0210003-1
FUEL TYPE	LPG   NG	LPG   NG
COLOR	BLACK	BLACK
HEAT AREA	160FT	215FT
ELECTRICAL CONNECTION	110V/2A	110V/2A
MINIMUM FLOOR CLEARANCE	96"	96"
OUTPUT	26,000 BTU	43,000 BTU

## MOUNTING OPTIONS

CEILING MOUNT	✓	✓
WALL MOUNT	✓	✓
RECESSED   FLUSH MOUNT	-	-
CEILING POLE MOUNT	✓	✓
FREESTANDING	-	-

## CONTROL OPTIONS

ON   OFF	✓	✓
ON   OFF PRODUCT CODE	BH3130010-1	BH3130010-1
DIMMER	-	-
MASTER REMOTE	-	-

Measurements displayed within this catalogue are minimum requirements for installation.  
Bromic takes no responsibility for incorrect or non-compliant installations.  
All measurement in this catalogue are displayed in inches.

## PRODUCT MEASUREMENTS

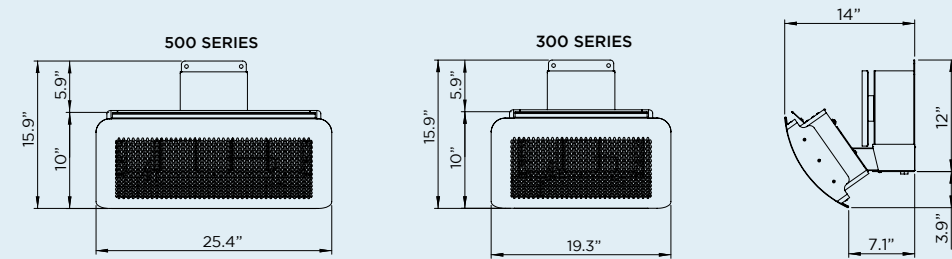

## PRODUCT MEASUREMENTS WITH HEAT DEFLECTOR

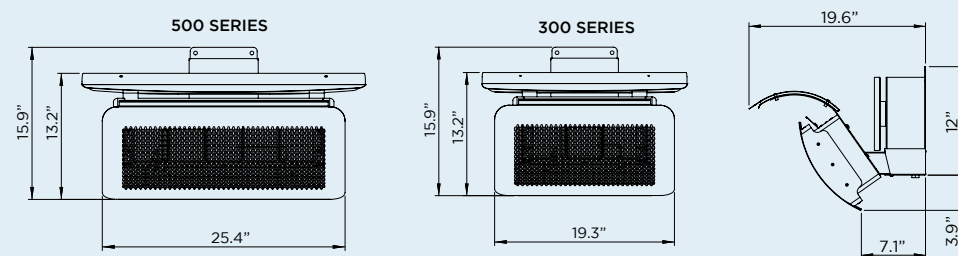

## CEILING & WALL MOUNT CLEARANCE

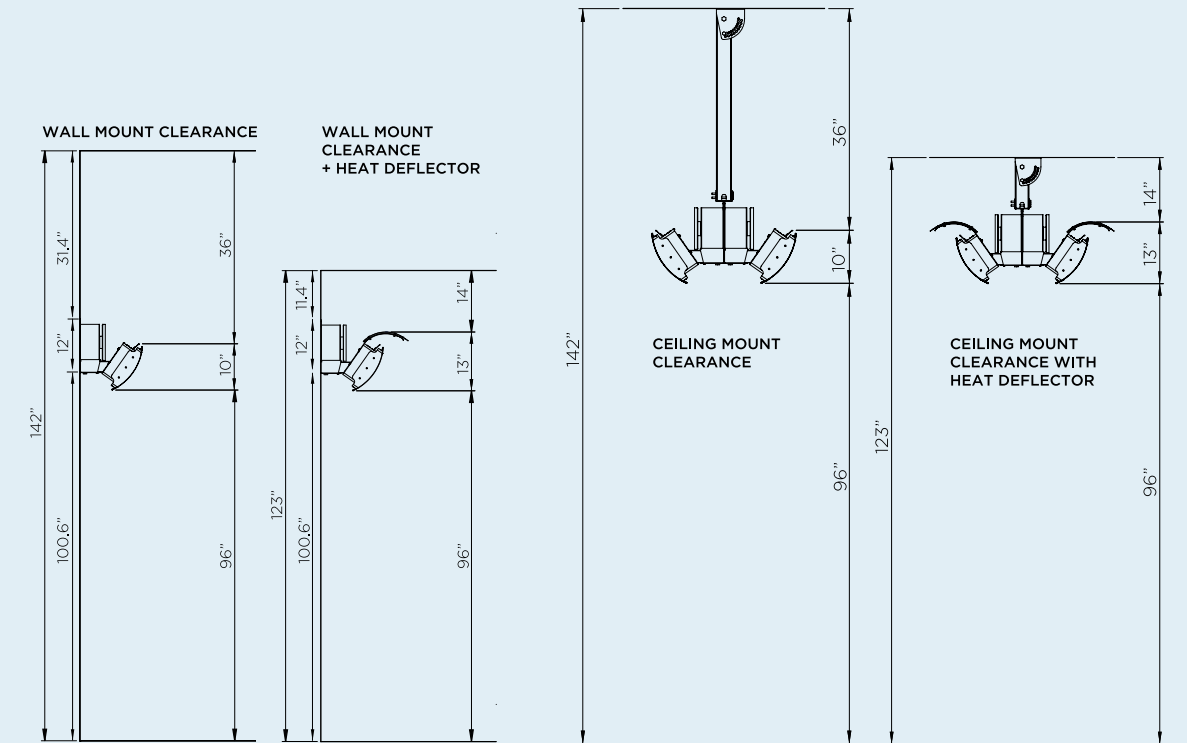

## WALL BRACKET

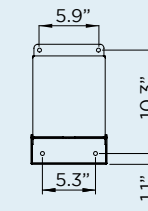

## HEAT AREA

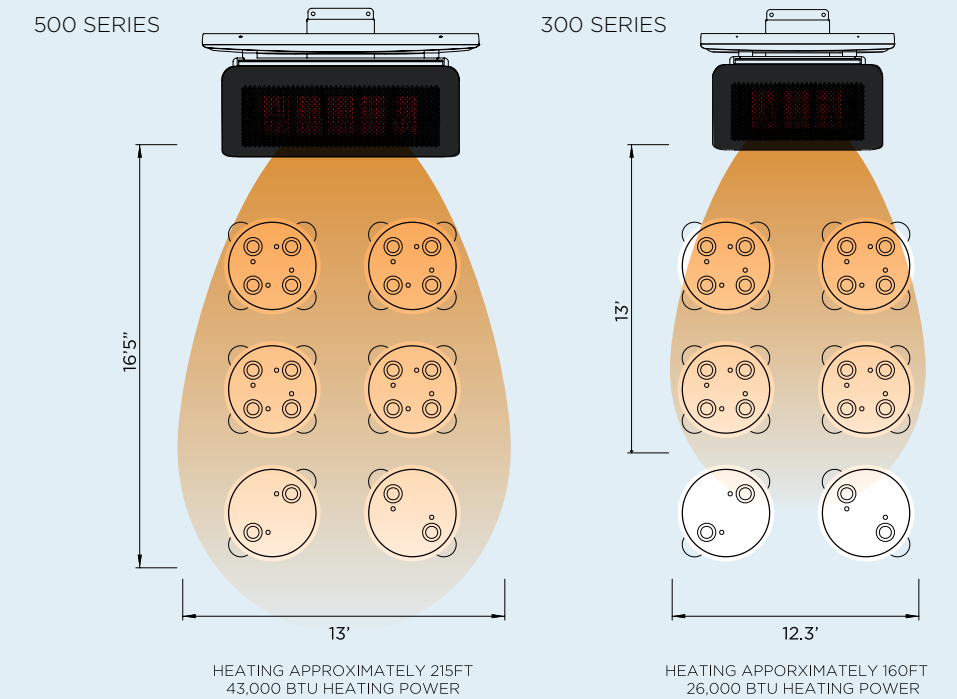

# TUNGSTEN SMART-HEAT™ ELECTRIC

MODEL NUMBER	2000 SERIES	3000 SERIES	4000 SERIES	6000 SERIES
PRODUCT CODE	BH0420030	BH0420031	BH0420032 BH0420012	BH0420033 BH0420013
FUEL TYPE	ELECTRIC	ELECTRIC	ELECTRIC	ELECTRIC
COLOUR	BLACK	BLACK	BLACK   WHITE	BLACK   WHITE
HEAT AREA	65FT	100FT	130FT	160FT
RATED CURRENT **	240V/8.3A 208V/9.62A 277V/7.22A	240V/12.5A 208V/14.42A 277V/10.83A	240V/16.6A 208V/19.23A 277V/14.44A	240V/25A 208V/28.85A 277V/21.66A
MINIMUM FLOOR CLEARANCE	WALL 72"   CEILING 96"		WALL 72"   CEILING 96"	
<b>MOUNTING OPTIONS</b>				
CEILING MOUNT	✓	✓	✓	✓
CEILING RECESS KIT PRODUCT CODES	BH8180010	BH8180011	BH8180010	BH8180011
WALL MOUNT	✓	✓	✓	✓
RECESSED   FLUSH MOUNT	✓	✓	✓	✓
CEILING POLE MOUNT	✓	✓	✓	✓
TUBE SUSPENSION KIT (36") PRODUCT CODE	BH8180012			
FREESTANDING	-	-	-	-
<b>CONTROL OPTIONS</b>				
ON   OFF	✓	✓	✓	✓
ON   OFF PRODUCT CODE	BH3130010-1			
DIMMER	✓	✓	✓	✓
DIMMER PRODUCT CODE	BH3130011-1			
MASTER REMOTE *	✓	✓	✓	✓

Measurements displayed within this document are minimum requirements for installation. Bromic takes no responsibility for incorrect or non-compliant installations. All measurement in this document are displayed in inches.

\*\* Available in varying voltages: 240V, 208V and 277V

\* Control up to six zones of heaters with unlimited heaters per zone from a single control. Works with dimming and on/off controllers. Control operates within 100ft of heaters.

## PRODUCT MEASUREMENTS

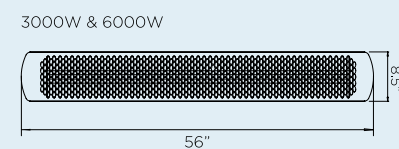
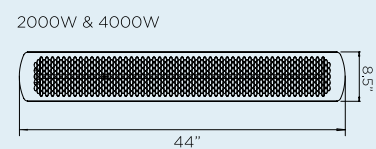

## CEILING RECESS

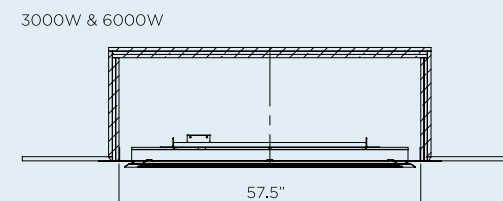
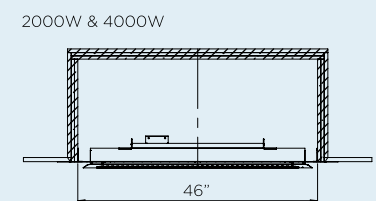
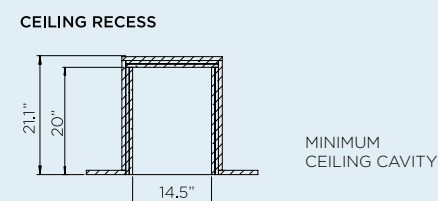
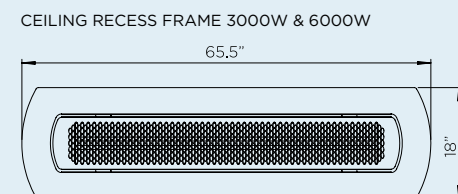
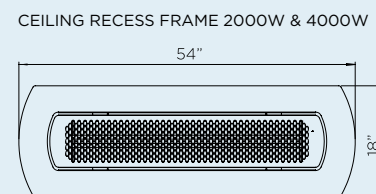

## CEILING & WALL MOUNT CLEARANCE

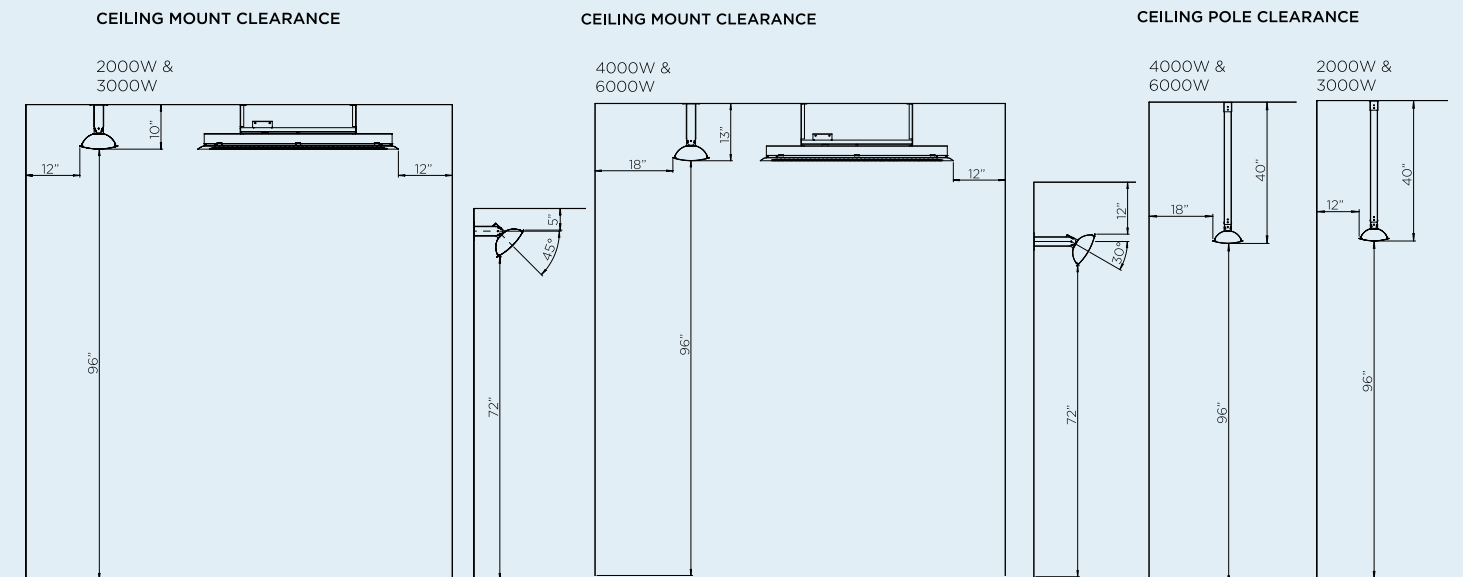

## WALL BRACKET (INCLUDED)



## HEAT AREA

### 2000W SERIES

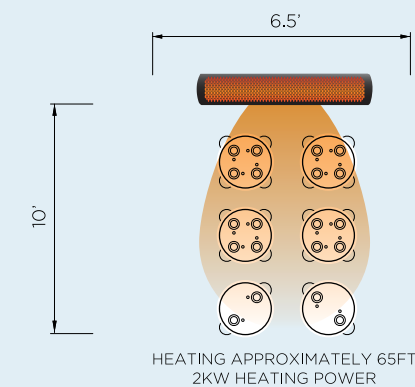

### 3000W SERIES

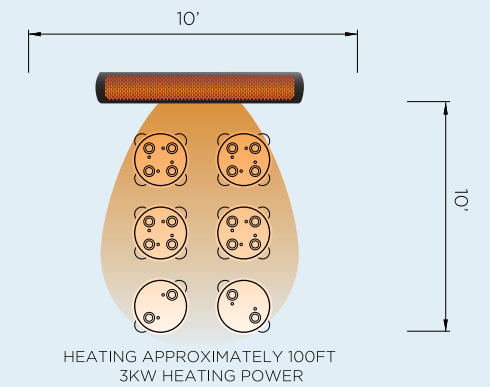

### 4000W SERIES

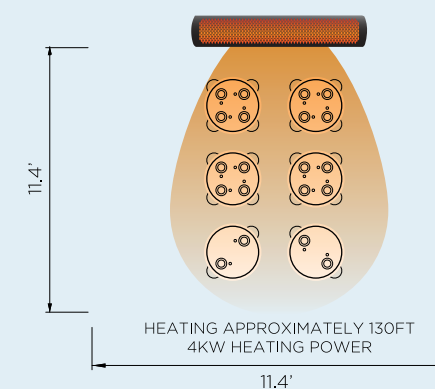

### 6000W SERIES

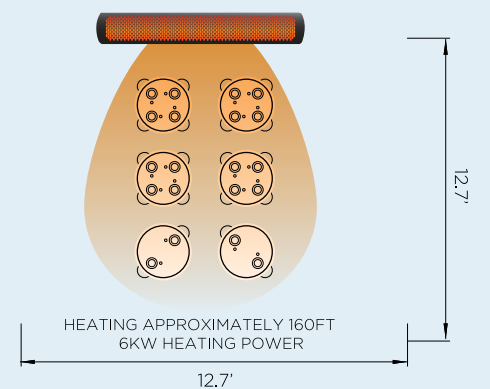

# TUNGSTEN SMART-HEAT™ PORTABLE

## MODEL NUMBER

PRODUCT CODE	BH0510001
FUEL TYPE	LPG   NG
COLOR	BLACK
HEAT AREA	215FT
ELECTRICAL CONNECTION	-
MINIMUM CEILING CLEARANCE	36"
OUTPUT	38,500 BTU

## MOUNTING OPTIONS

CEILING MOUNT	-
WALL MOUNT	-
RECESSED   FLUSH MOUNT	-
CEILING POLE MOUNT	-
FREESTANDING	✓

## CONTROL OPTIONS

ON   OFF	-
DIMMER	-
MASTER REMOTE	-

## ADDITIONAL OPTIONS

NATURAL GAS CONVERSION KIT PRODUCT CODE	BH8280050
HEATER COVER PRODUCT CODE	BH3030010

Measurements displayed within this catalogue are minimum requirements for installation. Bromic takes no responsibility for incorrect or non-compliant installations. All measurement in this catalogue are displayed in inches.

## PRODUCT MEASUREMENTS

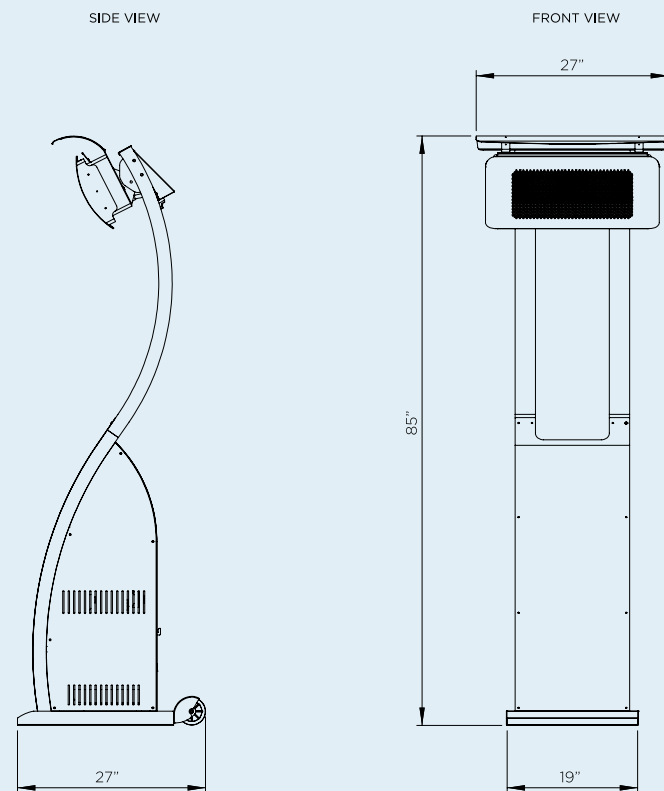

## CEILING & WALL CLEARANCE

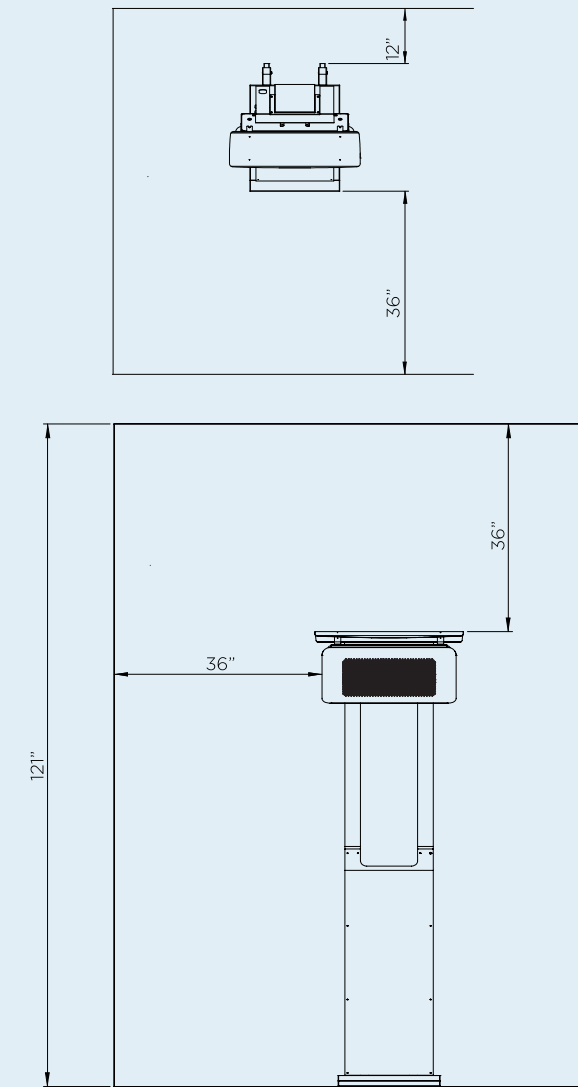

## HEAT AREA

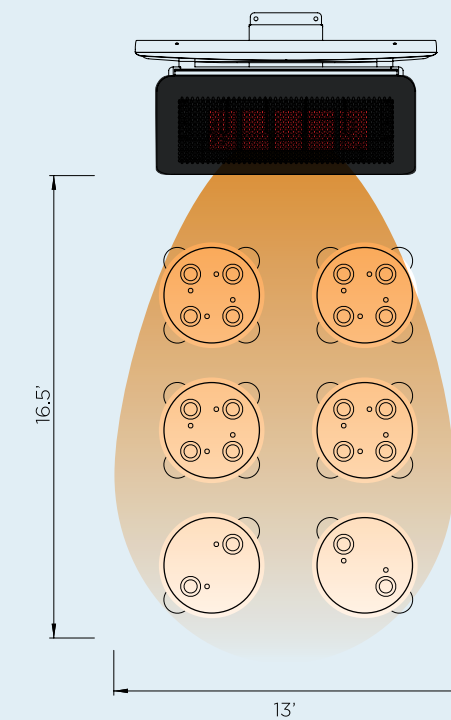

**TUNGSTEN PORTABLE**  
HEATING APPROXIMATELY 215FT  
38,500 BTU HEATING POWER





## DESIGN SERVICE

---

As part of our complimentary service, Bronic Heating Specialists will custom design and tailor a solution to best heat your outdoor living and entertainment spaces.

Learn more about our design service  
[bromic.com/designservice](https://bromic.com/designservice)





## ABOUT BROMIC GROUP

---

Bromic's reputation for industry and innovation reaches back to 1978. Initially a supplier of gas components, Bromic has since grown to become an international leader that designs, manufactures and distributes a diverse range of quality, engineered products on a global scale.

## CONTACT BROMIC

### **North America**

18 Technology Drive | STE 143  
Irvine California 92618 USA  
Tel. 1800 301 1293

### **Asia Pacific**

10 Phiney Place  
Ingleburn Sydney NSW 2565 AUS  
Tel. +61 2 9426 5222

### **Europe**

Hoofdstraat 43 | Business Center De Bank  
5481 AA Schijndel | The Netherlands  
Tel. +31 7 3704 1029

[BROMIC.COM/HEAT](https://www.bromic.com/HEAT)